

1 2 3 4 5 6

A

B

C

D

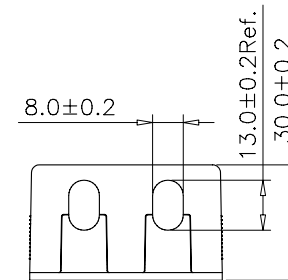
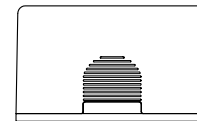
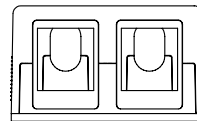
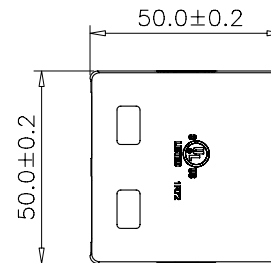
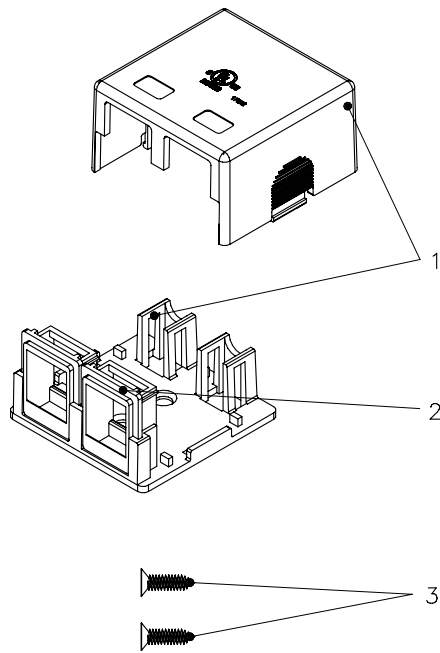

SCALE 1/2

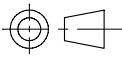
GENERAL TOLERANCE OF DIMENSIONS X.XXX ±0.005 X.XX ±0.05 X.X ±0.1	DRAWING	29.DEC.2010	YL	 <b>LANPRO</b> <i>How Information Moves...</i>
	CHECK	29.DEC.2010	KC	
	APPROVAL	29.DEC.2010	GR	
	DATE		NAME	
SCALE	1/2 (A4)	UNIT	mm	DES.: DOUBLE OUTLET SURFACE MOUNT MINI-BOX
		DRAWING NO. LP3302XX_DD_ENB01W		
		DRAWING CLASSIFICATION	S	SHEET 1 OF 1



1 2 3 4 5 6

10cm