

**LP-1521 User Manual High Speed Long Range 802.11b/g
54Mbps Wireless BroadBand Router, without PoE.**

LP1521_UM_ENB03W

**LP-1521 User Manual
High Speed Long Range 802.11b/g
54Mbps Wireless BroadBand Router,
without PoE.****400mW@ 802.11b/54Mbps,
200mW@ 802.11g/54Mbps****Default IP Address: 192.168.1.254
Default IP subnet mask: 255.255.255.0**

Trademarks**Copyright @2009**

Contents are subject to change without notice.
All trademarks belong to their respective proprietors.

Copyright Statement

THIS DOCUMENT CONTAINS OF PROPRIETARY TECHNICAL INFORMATION THAT IS THE PROPERTY OF THIS COMPANY. AND NO PART OF THIS DOCUMENTATION MAY BE REPRODUCED, STORED IN A RETRIEVAL SYSTEM OR TRANSMITTED IN ANY FORM OR BY ANY MEANS, ELECTRICAL OR MECHANICAL, BY PHOTOCOPYING, RECORDING, OR OTHERWISE, WITHOUT THE PRIOR WRITTEN CONSENT OF THIS COMPANY.

Federal Communication Commission Interference Statement

This equipment has been tested and found to comply with the limits for a Class B digital device, pursuant to Part 15 of the FCC Rules. These limits are designed to provide reasonable protection against harmful interference in a residential installation. This equipment generates, uses and can radiate radio frequency energy and, if not installed and used in accordance with the instructions, may cause harmful interference to radio communications. However, there is no guarantee that interference will not occur in a particular installation. If this equipment does cause harmful interference to radio or television reception, which can be determined by turning the equipment off and on, the user is encouraged to try to correct the interference by one of the following measures:

- Reorient or relocate the receiving antenna.
- Increase the separation between the equipment and receiver.
- Connect the equipment into an outlet on a circuit different from that to which the receiver is connected.
- Consult the dealer or an experienced radio/TV technician for help.

This device complies with Part 15 of the FCC Rules. Operation is subject to the following two conditions: (1) This device may not cause harmful interference, and (2) this device must accept any interference received, including interference that may cause undesired operation.

FCC Caution: Any changes or modifications not expressly approved by the party responsible for compliance could void the user's authority to operate this equipment.

IMPORTANT NOTE:**FCC Radiation Exposure Statement:**

This equipment complies with FCC radiation exposure limits set forth for an uncontrolled environment. This equipment should be installed and operated with minimum distance 20cm between the radiator & your body.
This transmitter must not be co-located or operating in conjunction with any other antenna or transmitter.

Revision History

DATE	REVISION OF USER'S MANUAL	FIRMWARE
2009/7/27	Version B01	(g/v)1.4.7

Terminology

3DES	Triple Data Encryption Standard
AES	Advanced Encryption Standard
ANSI	American National Standards Institute
AP	Access Point
CCK	Complementary Code Keying
CSMA/CA	Carrier Sense Multiple Access/ Collision Avoidance
CSMA/CD	Carrier Sense Multiple Access/ Collision Detection
DDNS	Dynamic Domain Name Server
DH	Diffie-Hellman Algorithm
DHCP	Dynamic Host Configuration Protocol
DSSS	Direct Sequence Spread Spectrum
EAP	Extensible Authentication Protocol
ESP	Encapsulating Security Payload
FCC	Federal Communications Commission
FTP	File Transfer Protocol
IEEE	Institute of Electrical and Electronic Engineers
IKE	Internet Key Exchange
IP	Internet Protocol
ISM	Industrial, Scientific and Medical
LAN	Local Area Network
MAC	Media Access Control
MD5	Message Digest 5
NAT	Network Address Translation
NT	Network Termination
NTP	Network Time Protocol
PPTP	Point to Point Tunneling Protocol
PSD	Power Spectral Density
RF	Radio Frequency
SHA1	Secure Hash Algorithm
SNR	Signal to Noise Ratio
SSID	Service Set Identification
TCP	Transmission Control Protocol
TFTP	Trivial File Transfer Protocol
TKIP	Temporal Key Integrity Protocol
UPNP	Universal Plug and Play
VPN	Virtual Private Network
WDS	Wireless Distribution System
WEP	Wired Equivalent Privacy
WLAN	Wireless Local Area Network
WPA	Wi-Fi Protected Access

1

Introduction

The Wireless LAN Broadband LanPro 1521 Router is an affordable IEEE 802.11b/g wireless LAN broadband router solution; setting SOHO and enterprise standard for high performance, secure, manageable and reliable WLAN.

This document describes the steps required for the initial IP address assign and other WLAN router configuration. The description includes the implementation of the above steps.

1.1 Package contents

The package of the WLAN Broadband Router includes the following items:

- The WLAN Broadband Router
- The AC to DC power adapter
- The Documentation CD
- 1.8M RJ-45 Cable Line (Option)

1.2 Product Specifications:

Product Name	High Speed Long Range 802.11b/g 54Mbps Wireless Super Power AP
Standard	802.11b/g(Wireless), 802.3(10BaseT), 802.3u(100BaseT)
Data Transfer Rate	54Mbps(Wireless), 100Mbps(Ethernet)
Chipset	Realtek RTL8186 180MHz
Memory Information:	16MB SDRAM, 2MB Flash
Modulation Method	IEEE 802.11b: CCK, DQPSK, DBPSK IEEE 802.11g: BPSK, QPSK, 16QAM, 64QAM DBPSK/ DQPSK/ CCK
RF Spreading Method	Direct Sequence Spread Spectrum (DSSS)
Frequency Band	N. America / FCC : 2.412 ~ 2.462 GHz (11 channels) Europe CE / ETSI : 2.412 ~ 2.472 GHz (13 channels) Japan : 2.412 ~ 2.484 GHz (14 channels) France : 2.457 ~ 2.472 GHz (4 channels) Spain : 2.457 ~ 2.462 GHz (2 channels)
Transmitter Characteristics	RF output power: <23 dBm (max.) @ 802.11g/54Mbps 200mw RF output power: < 26 dBm(max.) @ 802.11b/11Mbps. 400mw
Receiver Sensitivity	802.11b -98 dBm@8%, 802.11g -80 dBm@5%
Operation Range	200 to 1000 meters (depend on surrounding)
Antenna	External Antenna
LED	Power, Active (WLAN/Ethernet)
Security	64 bit/ 128 bit WEP, WPA, WPA2, port filtering, IP filtering, MAC filtering, port forwarding and DMZ hosting
LAN interface	One 10/100BaseT with RJ45 connector (WAN) Four 10/100BaseT with RJ45 connectors (LAN)
Power Consumption	12V DC Power Adapter
Operating Temperature	0 ~ 50oC ambient temperature
Storage Temperature	-20 ~ 70oC ambient temperature
Humidity	5 to 90 % maximum (non-condensing)
Dimension	118 x 95 x 25 mm

1.3 FEATURES

- Support passive 12V~22V 1A 802.3 POE
- 802.11b/g compliant
- WEP, WPA Encryption- 64/128bit (WEP), WPA TKIP
- Wireless users access control
- Wireless sites survey
- TCP/UDP/ICMP/ARP protocol stack
- Dynamic DNS
- WDS, AP, Client, WDS+AP
- VPN Pass-through with multiple sessions
- Supports firewall security with port filtering, IP filtering, MAC filtering, port forwarding, trigger port and DMZ hosting functions
- DHCP Client and Server
- WAN access mode
- PPPoE PPTP
- DHCP Client
- Fixed IP Address
- Log System (local and remote)
- Telnet
- TX Power control
- UPnP
- QoS
- Watchdog
- Hide SSID

1.4 LP-1521 Panel Description



Figure 1

LED Indicator	State	Description
1. Power LED	On	The WLAN Broadband Router is powered on.
	Off	The WLAN Broadband Router is powered off.
2. WLAN LED	Flashing	Data is transmitting or receiving on the antenna.
	Off	No data is transmitting or receiving on the antenna.
3. WAN LED ACT	Flashing	Data is transmitting or receiving on the WAN interface.
	Off	No data is transmitting or receiving on the WAN interface.
10/100M	On	Connection speed is 100Mbps on WAN interface.
	Off	Connection speed is 10Mbps on WAN interface.
4. LAN LED ACT	Flashing	Data is transmitting or receiving on the LAN interface.
	Off	No data is transmitting or receiving on the LAN interface.
10/100M	On	Connection speed is 100Mbps on LAN interface.
	Off	Connection speed is 10Mbps on LAN interface

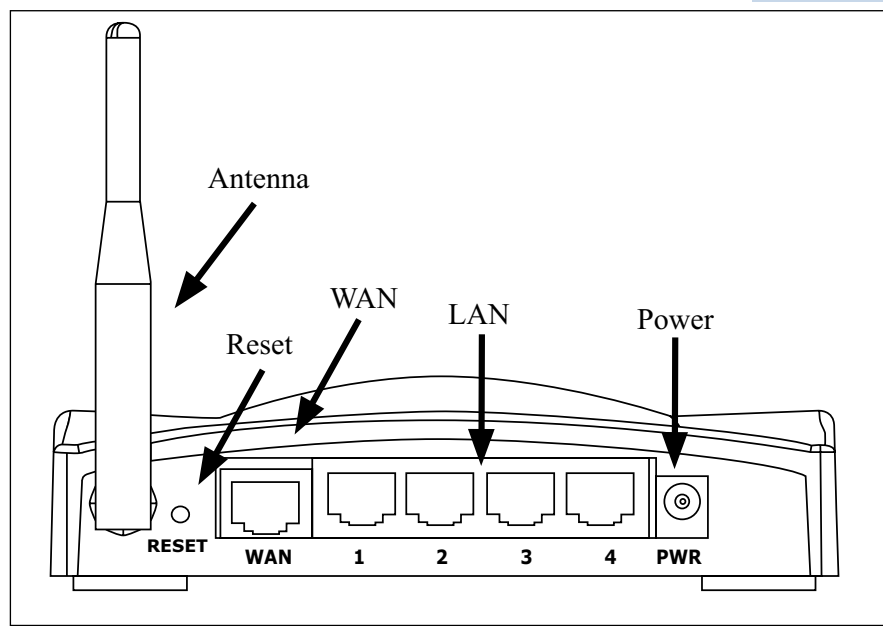

Figure 2

Interfaces	Description
1. Antenna	The Wireless LAN Antenna.
2. Reset	Push continually the reset button 5 ~ 10 seconds to reset the configuration parameters to factory defaults.
3. WAN	The RJ-45 socket allows WAN connection through a Category 5 cable. Support auto-sensing on 10/100M speed and half/ full duplex; comply with IEEE 802.3/ 802.3u respectively.
4. LAN	The RJ-45 sockets allow LAN connection through Category 5 cables. Support auto-sensing on 10/100M speed and half/ full duplex; comply with IEEE 802.3/ 802.3u respectively.
5. Power	The power jack allows an external DC +7.5 V power supply connection. The external AC to DC adaptor provide adaptive power requirement to the WLAN Broadband Router.

LP-1521 Back View



Figure 3

1.5 Hardware Installation

Step 1: Place the Wireless LAN Broadband Router to the best optimum transmission location. The best transmission location for your WLAN Broadband Router is usually at the geographic center of your wireless network, with line of sign to all of your mobile stations.

Step 2: Connect the WLAN Broadband Router to your wired network. Connect the Ethernet WAN interface of WLAN Broadband Router by category 5 Ethernet cable to your switch/ hub/ xDSL modem or cable modem. A straight-through Ethernet cable with appropriate cable length is needed.

Step 3: Supply DC power to the WLAN Broadband Router. Use only the AC/DC power adapter supplied with the WLAN Broadband Router; it may occur damage by using a different type of power adapter. The hardware installation finished.

1.6 Software Installation

- There are no software drivers, patches or utilities installation needed, but only the configuration setting. Please refer to chapter 3 for software configuration.

Notice: It will take about 55 seconds to complete the boot up sequence after powered on the WLAN Broadband Router; Power LED will be active, and after that the WLAN Activity LED will be flashing to show the WLAN interface is enabled and working now.

2

Software configuration

There are web based management and configuration functions allowing you to have the jobs done easily.

The WLAN Broadband Router is delivered with the following factory default parameters on the Ethernet LAN interfaces.

Default IP Address: **192.168.1.254**

Default IP subnet mask: **255.255.255.0**

WEB login User Name: **<empty>**

WEB login Password: **<empty>**

Prepare your PC to configure the WLAN Broadband Router

For OS of Microsoft Windows 95/ 98/ Me:

1 Click the **Start** button and select **Settings**, then click **Control Panel**. The **Control Panel** window will appear.

Note: Windows Me users may not see the Network control panel. If so, select **View all Control Panel** options on the left side of the window

2 Move mouse and double-click the right button on **Network** icon. The **Network** window will appear.

3 Check the installed list of **Network Components**. If TCP/IP is not installed, click the **Add** button to install it; otherwise go to step 6.

4 Select **Protocol** in the **Network Component Type** dialog box and click **Add** button.

5 Select **TCP/IP** in **Microsoft** of **Select Network Protocol** dialog box then click OK button to install the TCP/IP protocol, it may need the Microsoft Windows CD to complete the installation. Close and go back to **Network** dialog box after the TCP/IP installation.

6 Select **TCP/IP** and click the **properties** button on the **Network** dialog box.

7 Select **Specify an IP address** and type in values as following example.

- IP Address: **192.168.1.254**, any IP address within 192.168.1.1 to 192.168.1.253 is good to connect the Wireless LAN Access Point.

- IP Subnet Mask: **255.255.255.0**

8 Click OK and reboot your PC after completes the IP parameters setting.

For OS of Microsoft Windows 2000, XP:

1 Click the **Start** button and select **Settings**, then click **Control Panel**. The **Control Panel** window will appear.

2 Move mouse and double-click the right button on **Network and Dial-up Connections** icon. Move mouse and double-click the Local Area Connection icon. The **Local Area Connection** window will appear. Click Properties button in the Local Area Connection window.

3 Check the installed list of **Network Components**. If TCP/IP is not installed, click the **Add** button to install it; otherwise go to step 6.

4 Select **Protocol** in the **Network Component Type** dialog box and click **Add** button.

5 Select **TCP/IP** in **Microsoft** of **Select Network Protocol** dialog box then click OK button to install the TCP/IP protocol, it may need the Microsoft Windows CD to complete the installation. Close and go back to **Network** dialog box after the TCP/IP installation.

6 Select **TCP/IP** and click the **properties** button on the **Network** dialog box.

7 Select **Specify an IP address** and type in values as following example.

- IP Address: **192.168.1.254**, any IP address within 192.168.1.1 to 192.168.1.253 is good to connect the Wireless LAN Access Point.

- IP Subnet Mask: **255.255.255.0**

- 8 Click OK to completes the IP parameters setting.

For OS of Microsoft Windows NT:

- 1 Click the **Start** button and select **Settings**, then click **Control Panel**. The **Control Panel** window will appear.
- 2 Move mouse and double-click the right button on **Network** icon. The **Network** window will appear. Click **Protocol** tab from the **Network** window.
- 3 Check the installed list of **Network Protocol** window. If TCP/IP is not installed, click the **Add** button to install it; otherwise go to step 6.
- 4 Select **Protocol** in the **Network Component Type** dialog box and click **Add** button.
- 5 Select **TCP/IP** in **Microsoft** of **Select Network Protocol** dialog box then click OK button to install the TCP/IP protocol, it may need the Microsoft Windows CD to complete the installation. Close and go back to **Network** dialog box after the TCP/IP installation.
- 6 Select **TCP/IP** and click the properties button on the **Network** dialog box.
- 7 Select **Specify an IP address** and type in values as following example.
 - IP Address: **192.168.1.254**, any IP address within 192.168.1.1 to 192.168.1.253 is good to connect the Wireless LAN Access Point.
 - IP Subnet Mask: **255.255.255.0**
- 8 Click OK to complete the IP parameters setting.

Connect to the LP-1521 WLAN Broadband Router

Open a WEB browser, i.e. Microsoft Internet Explore, then enter 192.168.1.254 on the URL to connect the WLAN Broadband Router.

Management and configuration on the WLAN Broadband Router

Status

This page shows the current status and some basic settings of the device, includes system, wireless, Ethernet LAN and WAN configuration information.

Broadband Router Status	
This page shows the current status and some basic settings of the device.	
System	
Uptime	0day:0h:0m:24s
Firmware Version	v1.4.7.ep.TPC_D_eng1
Wireless Configuration	
Mode	AP
Band	2.4 GHz (B+G)
SSID	LanPro LP-1521
Channel Number	11
Encryption	Disabled
BSSID	00:27:11:00:88:b4
Associated Clients	0
TCP/IP Configuration	
Attain IP Protocol	Fixed IP
IP Address	192.168.1.254
Subnet Mask	255.255.255.0
Default Gateway	192.168.1.254
DHCP Server	Enabled
MAC Address	00:27:11:00:88:b4
WAN Configuration	
Attain IP Protocol	Getting IP from DHCP server...
IP Address	0.0.0.0
Subnet Mask	0.0.0.0
Default Gateway	0.0.0.0

Screen snapshot – Status

Figure 4

Item	Description
System	
Uptime	It shows the duration since WLAN Broadband Router is powered on.
Firmware version	It shows the firmware version of WLAN Broadband Router.
Wireless configuration	
Mode	It shows wireless operation mode
Band	It shows the current wireless operating frequency.
SSID	It shows the SSID of this WLAN Broadband Router. The SSID is the unique name of WLAN Broadband Router and shared among its service area, so all devices attempts to join the same wireless network can identify it.
Channel Number	It shows the wireless channel connected currently.
Encryption	It shows the status of encryption function.
BSSID	It shows the BSSID address of the WLAN Broadband Router. BSSID is a six-byte address.
Associated Clients	It shows the number of connected clients (or stations, PCs).
TCP/IP configuration	
Attain IP Protocol	It shows type of connection.
IP Address	It shows the IP address of LAN interfaces of WLAN Broadband Router.
Subnet Mask	It shows the IP subnet mask of LAN interfaces of WLAN Broadband Router.
Default Gateway	It shows the default gateway setting for LAN interfaces outgoing data packets.
DHCP Server	It shows the DHCP server is enabled or not.
MAC Address	It shows the MAC address of LAN interfaces of WLAN Broadband Router.
WAN configuration	
Attain IP Protocol	It shows how the WLAN Broadband Router gets the IP address. The IP address can be set manually to a fixed one or set dynamically by DHCP server or attain IP by PPPoE / PPTP connection.
IP Address	It shows the IP address of WAN interface of WLAN Broadband Router.
Subnet Mask	It shows the IP subnet mask of WAN interface of WLAN Broadband Router.
Default Gateway	It shows the default gateway setting for WAN interface outgoing data packets.
MAC Address	It shows the MAC address of WAN interface of WLAN Broadband Router.

Setup Wizard

This page guides you to configure wireless broadband router for first time



Figure 5

Screen snapshot – Setup Wizard

I Operation Mode

This page followed by Setup Wizard page to define the operation mode.

Screen snapshot – Operation Mode

Figure 6

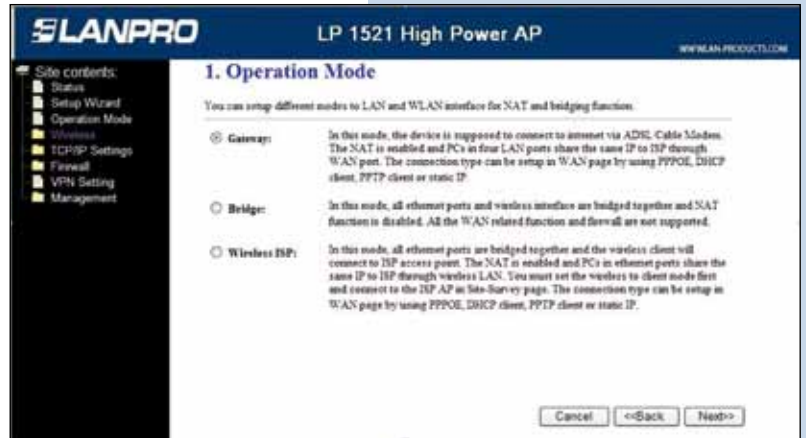

II Time Zone Setting

This page is used to enable and configure NTP client

Screen snapshot – Time Zone Settings

Figure 7



III LAN Interface Setup

This page is used to configure local area network IP address and subnet mask

Screen snapshot – LAN Interface Setup

Figure 8

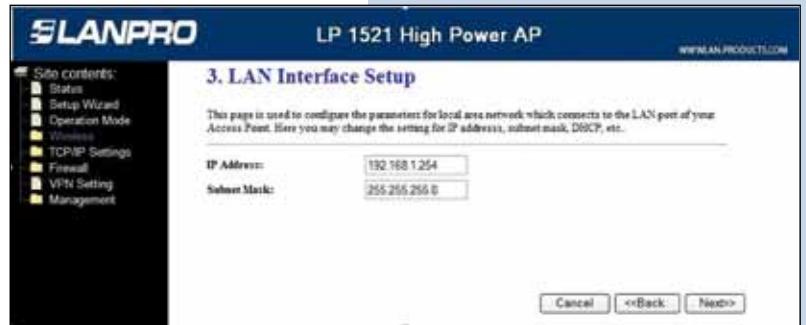

IV WAN Interface Setup

This page is used to configure WAN access type

Screen snapshot – WAN Interface Setup

Figure 9



V LP-1521 Wireless Basic Settings

This page is used to configure basic wireless parameters like Band, Mode, Network Type SSID, Channel Number, Enable Mac Clone(Single Ethernet Client).

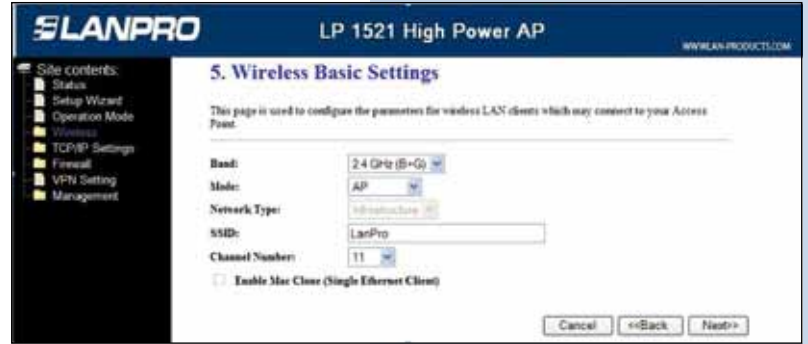

Screen snapshot – Wireless Basic Settings

Figure 10

VI Wireless Security Setup

This page is used to configure wireless security



Screen snapshot – Wireless Security Setup

Figure 11

Operation Mode

This page is used to configure which mode wireless broadband router acts.

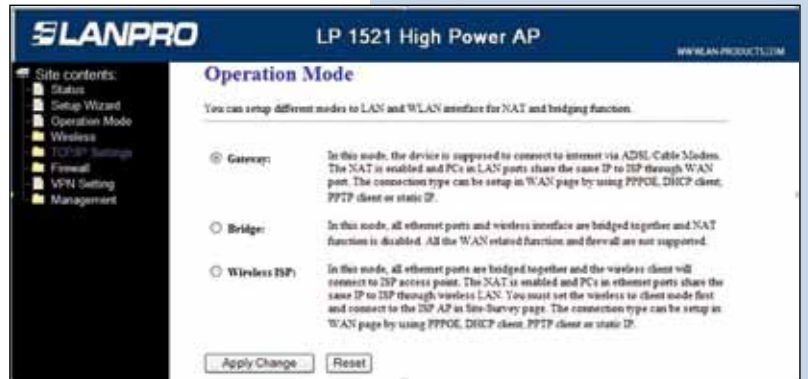

Screen snapshot – Operation Mode

Figure 12

Item	Description
Gateway	Traditional gateway configuration. It always connects internet via ADSL/Cable Modem. LAN interface, WAN interface, Wireless interface, NAT and Firewall modules are applied to this mode
Bridge	Each interface (LAN, WAN and Wireless) regards as bridge. NAT, Firewall and all router's functions are not supported
Wireless ISP	Switch Wireless interface to WAN port and all Ethernet ports in bridge mode. Wireless interface can do all router's functions
Apply Changes	Click the Apply Changes button to complete the new configuration setting.
Reset	Click the Reset button to abort change and recover the previous configuration setting.

Wireless - Basic Settings

This page is used to configure the parameters for wireless LAN clients that may connect to your Broadband Router. Here you may change wireless encryption settings as well as wireless network parameters.



Screen snapshot – Wireless Basic Settings

Figure 13

Item	Description
Disable Wireless LAN Interface	Click on to disable the wireless LAN data transmission
Band	Click to select 2.4GHz(B) / 2.4GHz(G) / 2.4GHz(B+G)
Mode	Click to select the WLAN AP / Client / WDS / AP+WDS wireless mode.
Site Survey	The Site Survey button provides tool to scan the wireless network. If any Access Point or IBSS is found, you could choose to connect it manually when client mode is enabled. Refer to 3.3.9 Site Survey.
SSID	It is the wireless network name. The SSID can be 32 bytes long.
Channel Number	Select the wireless communication channel from pull-down menu.
Associated Clients	Click the Show Active Clients button to open Active Wireless Client Table that shows the MAC address, transmit-packet, receive-packet and transmission-rate for each associated wireless client.
Enable Mac Clone (Single Ethernet Client)	Take Laptop NIC MAC address as wireless client MAC address. [Client Mode only]
Enable Universal Repeater Mode	Click to enable Universal Repeater Mode
SSID of Extended Interface	Assign SSID when enables Universal Repeater Mode.
Apply Changes	Click the Apply Changes button to complete the new configuration setting.
Reset	Click the Reset button to abort change and recover the previous configuration setting.

Wireless - Advanced Settings

These settings are only for more technically advanced users who have a sufficient knowledge about wireless LAN. These settings should not be changed unless you know what effect the changes will have on your WLAN Broadband Router.



Screen snapshot – Operation Mode

Figure 14

Item	Description
Authentication Type	Click to select the authentication type in Open System, Shared Key or Auto selection.
Fragment Threshold	Set the data packet fragmentation threshold, value can be written between 256 and 2346 bytes. Refer to 4.10 What is Fragment Threshold?
RTS Threshold	Set the RTS Threshold, value can be written between 0 and 2347 bytes. Refer to 4.11 What is RTS(Request To Send) Threshold?
Beacon Interval	Set the Beacon Interval, value can be written between 20 and 1024 ms. Refer to 4.12 What is Beacon Interval?
Data Rate	Select the transmission data rate from pull-down menu. Data rate can be auto-select, 11M, 5.5M, 2M or 1Mbps.
Broadcast SSID	Click to enable or disable the SSID broadcast function. Refer to 4.14 What is SSID Broadcast?
IAPP	Click to enable or disable the IAPP function. Refer to 4.20 What is Inter-Access Point Protocol(IAPP)?
802.11g Protection	Protect 802.11b user.
RF Output Power	To adjust transmission power level.
Turbo Mode	Click to enable/disable turbo mode. (Only apply to WLAN IC of Realtek).
Apply Changes	Click the Apply Changes button to complete the new configuration setting.
Reset	Click the Reset button to abort change and recover the previous configuration setting.

Wireless - Security Setup

This page allows you setup the wireless security. Turn on WEP, WPA, WPA2 by using encryption keys could prevent any unauthorized access to your wireless network.



Screen snapshot – Wireless Security Setup

Figure 15

Item	Description
Encryption	Select the encryption supported over wireless access. The encryption method can be None, WEP, WPA(TKIP), WPA2 or WPA2 Mixed Refer to 4.9 What is WEP? 4.15 What is Wi-Fi Protected Access (WPA)? 4.16 What is WPA2(AES)? 4.17 What is 802.1X Authentication? 4.18 What is Temporal Key Integrity Protocol (TKIP)? 4.19 What is Advanced Encryption Standard (AES)?
Use 802.1x Authentication	While Encryption is selected to be WEP. Click the check box to enable IEEE 802.1x authentication function. Refer to 4.16 What is 802.1x Authentication?
WPA Authentication Mode	While Encryption is selected to be WPA. Click to select the WPA Authentication Mode with Enterprise (RADIUS) or Personal (Pre-Shared Key). Refer to 4.15 What is Wi-Fi Protected Access (WPA)?
Pre-Shared Key Format	While Encryption is selected to be WPA. Select the Pre-shared key format from the pull-down menu. The format can be Passphrase or Hex (64 characters). [WPA, Personal(Pre-Shared Key) only]
Pre-Shared Key	Fill in the key value. [WPA, Personal(Pre-Shared Key) only]
Enable Pre-Authentication	Click to enable Pre-Authentication. [WPA2/WPA2 Mixed only, Enterprise only]
Authentication RADIUS Server	Set the IP address, port and login password information of authentication RADIUS sever.
Apply Changes	Click the Apply Changes button to complete the new configuration setting.
Reset	Click the Reset button to abort change and recover the previous configuration setting.

VII WEP Key Setup



Screen snapshot – WEP Key Setup

Figure 16

Item	Description
Key Length	Select the WEP shared secret key length from pull-down menu. The length can be chose between 64-bit and 128-bit (known as "WEP2") keys. The WEP key is composed of initialization vector (24 bits) and secret key (40-bit or 104-bit).
Key Format	Select the WEP shared secret key format from pull-down menu. The format can be chose between plant text (ASCII) and hexadecimal (HEX) code
Default Tx Key	Set the default secret key for WEP security function. Value can be chose between 1 and 4.
Encryption Key 1	Secret key 1 of WEP security encryption function.
Encryption Key 2	Secret key 2 of WEP security encryption function.
Encryption Key 3	Secret key 3 of WEP security encryption function.
Encryption Key 4	Secret key 4 of WEP security encryption function.
Apply Changes	Click the Apply Changes button to complete the new configuration setting.
Close	Click to close this WEP Key setup window.
Reset	Click the Reset button to abort change and recover the previous configuration setting.

Previous configuration setting.

WEP encryption key (secret key) length:

Length Format	64-bit	128-bit
ASCII	5 characters	13 characters
HEX	10 hexadecimal codes	26 hexadecimal codes

Wireless - Access Control

If you enable wireless access control, only those clients whose wireless MAC addresses are in the access control list will be able to connect to your Access Point. When this option is enabled, no wireless clients will be able to connect if the list contains no entries.

Screen snapshot – Wireless Access Control
Figure 17

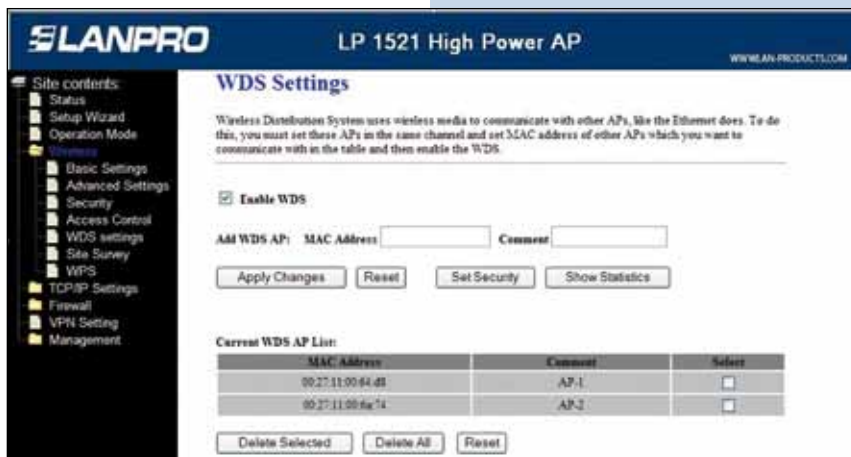

Item	Description
Wireless Access Control Mode	Click the Disabled, Allow Listed or Deny Listed of drop down menu choose wireless access control mode. This is a security control function; only those clients registered in the access control list can link to this WLAN Broadband Router.
MAC Address	Fill in the MAC address of client to register this WLAN Broadband Router access capability.
Comment	Fill in the comment tag for the registered client.
Apply Changes	Click the Apply Changes button to register the client to new configuration setting.
Reset	Click the Reset button to abort change and recover the previous configuration setting.
Current Access Control List	It shows the registered clients that are allowed to link to this WLAN Broadband Router.
Delete Selected	Click to delete the selected clients that will be access right removed from this WLAN Broadband Router.
Delete All	Click to delete all the registered clients from the access allowed list.
Reset	Click the Reset button to abort change and recover the previous configuration setting.

LP-1521 WDS Settings

Wireless Distribution System uses wireless media to communicate with other APs, like the Ethernet does. To do this, you must set these APs in the same channel and set MAC address of other AP that you want to communicate with in the table and then enable the WDS.

Screen snapshot – WDS Setup
Figure 18

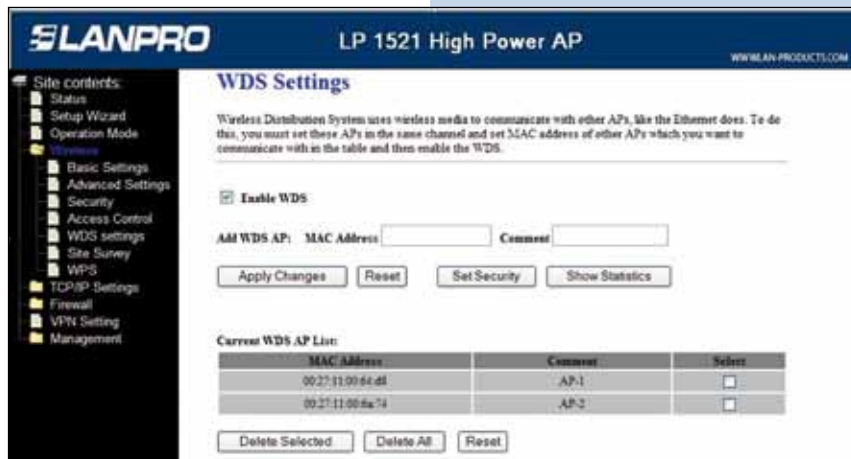

Item	Description
Enable WDS	Click the check box to enable wireless distribution system. Refer to 4.21 What is Wireless Distribution System (WDS)?
MAC Address	Fill in the MAC address of AP to register the wireless distribution system access capability.
Comment	Fill in the comment tag for the registered AP.
Apply Changes	Click the Apply Changes button to register the AP to new configuration setting.
Reset	Click the Reset button to abort change and recover the previous configuration setting.
Set Security	Click button to configure wireless security like WEP(64bits), WEP(128bits), WPA(TKIP), WPA2(AES) or None
Show Statistics	It shows the TX, RX packets, rate statistics
Delete Selected	Click to delete the selected clients that will be removed from the wireless distribution system.
Delete All	Click to delete all the registered APs from the wireless distribution system allowed list.
Reset	Click the Reset button to abort change and recover the previous configuration setting.

VIII WDS Security Setup

Requirement: Set [Wireless]->[Basic Settings]->[Mode]->AP+WDS

This page is used to configure the wireless security between APs. Refer to [3.3.6 Wireless Security Setup](#).



Screen snapshot – WDS Security Setup

Figure 19

IX WDS AP Table

This page is used to show WDS statistics

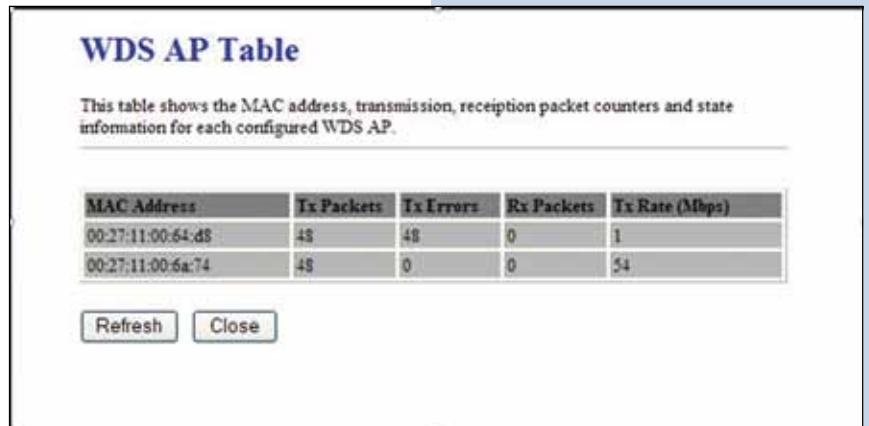

Screen snapshot – WDS AP Table

Figure 20

Item	Description
MAC Address	It shows the MAC Address within WDS.
Tx Packets	It shows the statistic count of sent packets on the wireless LAN interface.
Tx Errors	It shows the statistic count of error sent packets on the Wireless LAN interface.
Rx Packets	It shows the statistic count of received packets on the wireless LAN interface.
Tx Rate (Mbps)	It shows the wireless link rate within WDS.
Refresh	Click to refresh the statistic counters on the screen.
Close	Click to close the current window

Site Survey

This page is used to view or configure other APs near yours.

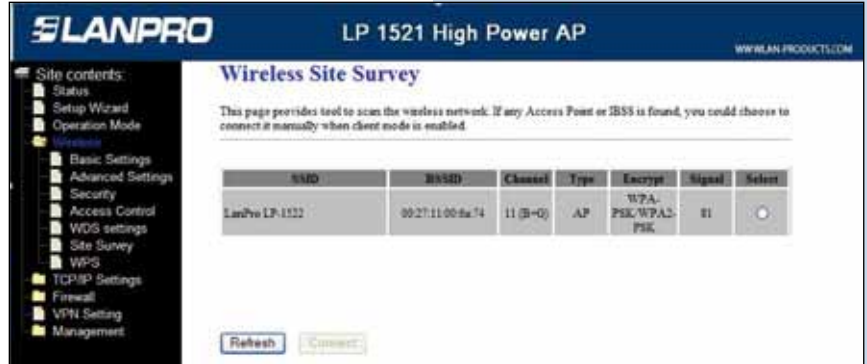

Screen snapshot – Wireless Site Survey

Figure 21

Item	Description
SSID	It shows the SSID of AP.
BSSID	It shows BSSID of AP.
Channel	It show the current channel of AP occupied.
Type	It show which type AP acts.
Encrypt	It shows the encryption status.
Signal	It shows the power level of current AP.
Select	Click to select AP or client you'd like to connect.
Refresh	Click the Refresh button to re-scan site survey on the screen.
Connect	Click the Connect button to establish connection.

LAN Interface Setup

This page is used to configure the parameters for local area network that connects to the LAN ports of your WLAN Broadband Router. Here you may change the setting for IP address, subnet mask, DHCP, etc.



Screen snapshot – LAN Interface Setup

Figure 22

Item	Description
IP Address	Fill in the IP address of LAN interfaces of this WLAN Access Point.
Subnet Mask	Fill in the subnet mask of LAN interfaces of this WLAN Access Point.
Default Gateway	Fill in the default gateway for LAN interfaces out going data packets.
DHCP	Click to select Disabled , Client or Server in different operation mode of wireless Access Point.
DHCP Client Range	Fill in the start IP address and end IP address to allocate a range of IP addresses; client with DHCP function set will be assigned an IP address from the range.
Show Client	Click to open the Active DHCP Client Table window that shows the active clients with their assigned IP address, MAC address and time expired information. [Server mode only]
DNS Server	Manual setup DNS server IP address.
Domain Name	Assign Domain Name and dispatch to DHCP clients. It is optional field.
802.1d Spanning Tree	Select to enable or disable the IEEE 802.1d Spanning Tree function from pull-down menu.
Clone MAC Address	Fill in the MAC address that is the MAC address to be cloned. Refer to 4.24 What is Clone MAC Address?
Apply Changes	Click the Apply Changes button to complete the new configuration setting.
Reset	Click the Reset button to abort change and recover the previous configuration setting.

WAN Interface Setup

This page is used to configure the parameters for wide area network that connects to the WAN port of your WLAN Broadband Router. Here you may change the access method to **Static IP, DHCP, PPPoE** or **PPTP** by click the item value of **WAN Access Type**.

X Static IP



Screen snapshot – WAN Interface Setup – Static IP
Figure 23

Item	Description
Static IP	Click to select Static IP support on WAN interface. There are IP address, subnet mask and default gateway settings need to be done.
IP Address	If you select the Static IP support on WAN interface, fill in the IP address for it.
Subnet Mask	If you select the Static IP support on WAN interface, fill in the subnet mask for it.
Default Gateway	If you select the Static IP support on WAN interface, fill in the default gateway for WAN interface out going data packets.
MTU Size	Fill in the mtu size of MTU Size. The default value is 1400
DNS 1	Fill in the IP address of Domain Name Server 1.
DNS 2	Fill in the IP address of Domain Name Server 2.
DNS 3	Fill in the IP address of Domain Name Server 3.
Clone MAC Address	Fill in the MAC address that is the MAC address to be cloned. Refer to 4.24 What is Clone MAC Address?
Enable uPNP	Click the checkbox to enable uPNP function. Refer to 4.22 What is Universal Plug and Play (uPNP)?
Enable Web Server Access on WAN	Click the checkbox to enable web configuration from WAN side.
Enable WAN Echo Reply	Click the checkbox to enable WAN ICMP response.
Enable IPsec pass through on VPN connection	Click the checkbox to enable IPsec packet pass through
Enable PPTP pass through on VPN connection	Click the checkbox to enable PPTP packet pass through
Enable L2TP pass through on VPN connection	Click the checkbox to enable L2TP packet pass through
Apply Changes	Click the Apply Changes button to complete the new configuration setting
Reset	Click the Reset button to abort change and recover the previous configuration setting.

XI DHCP Client



Screen snapshot – WAN Interface Setup – DHCP Client

Figure 24

Item	Description
DHCP Client	Click to select DHCP support on WAN interface for IP address assigned automatically from a DHCP server.
Host Name	Fill in the host name of Host Name. The default value is empty
MTU Size	Fill in the mtu size of MTU Size. The default value is 1400
Attain DNS Automatically	Click to select getting DNS address for DHCP support. Please select Set DNS Manually if the DHCP support is selected.
Set DNS Manually	Click to select getting DNS address for DHCP support.
DNS 1	Fill in the IP address of Domain Name Server 1.
DNS 2	Fill in the IP address of Domain Name Server 2.
DNS 3	Fill in the IP address of Domain Name Server 3.
Clone MAC Address	Fill in the MAC address that is the MAC address to be cloned. Refer to 4.24 What is Clone MAC Address?
Enable uPNP	Click the checkbox to enable uPNP function. Refer to 4.22 What is Universal Plug and Play (uPNP)?
Enable Web Server Access on WAN	Click the checkbox to enable web configuration from WAN side.
Enable WAN Echo Reply	Click the checkbox to enable WAN ICMP response.
Apply Changes	Click the Apply Changes button to complete the new configuration setting.
Reset	Click the Reset button to abort change and recover the previous configuration setting.

XII PPPoE



Screen snapshot – WAN Interface Setup – PPPoE
Figure 25

Item	Description
PPPoE	Click to select PPPoE support on WAN interface. There are user name, password, connection type and idle time settings need to be done.
User Name	If you select the PPPoE support on WAN interface, fill in the user name and password to login the PPPoE server.
Password	If you select the PPPoE support on WAN interface, fill in the user name and password to login the PPPoE server.
Service Name	Fill in the service name of Service Name. The default value is empty.
Connection Type	Select the connection type from pull-down menu. There are Continuous , Connect on Demand and Manual three types to select. Continuous connection type means to setup the connection through PPPoE protocol whenever this WLAN Broadband Router is powered on. Connect on Demand connection type means to setup the connection through PPPoE protocol whenever you send the data packets out through the WAN interface; there are a watchdog implemented to close the PPPoE connection while there are no data sent out longer than the idle time set. Manual connection type means to setup the connection through the PPPoE protocol by clicking the Connect button manually, and clicking the Disconnect button manually.
Idle Time	If you select the PPPoE and Connect on Demand connection type, fill in the idle time for auto-disconnect function. Value can be between 1 and 1000 minutes.
MTU Size	Fill in the mtu size of MTU Size. The default value is 1400. Refer to 4.23 What is Maximum Transmission Unit (MTU) Size?
Attain DNS Automatically	Click to select getting DNS address for PPPoE support. Please select Set DNS Manually if the PPPoE support is selected.
Set DNS Manually	Click to select getting DNS address for Static IP support.
DNS 1	Fill in the IP address of Domain Name Server 1.
DNS 2	Fill in the IP address of Domain Name Server 2.
DNS 3	Fill in the IP address of Domain Name Server 3.
Clone MAC Address	Fill in the MAC address that is the MAC address to be cloned. Refer to 4.24 What is Clone MAC Address?
Enable uPNP	Click the checkbox to enable uPNP function. Refer to 4.22 What is Universal Plug and Play (uPNP)?
Enable Web Server Access on WAN	Click the checkbox to enable web configuration from WAN side.
Enable WAN Echo Reply	Click the checkbox to enable WAN ICMP response.
Apply Changes	Click the Apply Changes button to complete the new configuration setting.
Reset	Click the Reset button to abort change and recover the previous configuration setting.

XIII PPTP



Screen snapshot – WAN Interface Setup – PPTP

Figure 26

Item	Description
PPTP	Allow user to make a tunnel with remote site directly to secure the data transmission among the connection. User can use embedded PPTP client supported by this router to make a VPN connection.
IP Address	If you select the PPTP support on WAN interface, fill in the IP address for it.
Subnet Mask	If you select the PPTP support on WAN interface, fill in the subnet mask for it.
Server IP Address	Enter the IP address of the PPTP Server.
User Name	If you select the PPTP support on WAN interface, fill in the user name and password to login the PPTP server.
Password	If you select the PPTP support on WAN interface, fill in the user name and password to login the PPTP server.
MTU Size	Fill in the mtu size of MTU Size. The default value is 1400. Refer to 4.23 What is Maximum Transmission Unit (MTU) Size?
Request MPPE Encryption	Click the checkbox to enable request MPPE encryption.
Attain DNS Automatically	Click to select getting DNS address for PPTP support. Please select Set DNS Manually if the PPTP support is selected.
Set DNS Manually	Click to select getting DNS address for PPTP support.
DNS 1	Fill in the IP address of Domain Name Server 1.
DNS 2	Fill in the IP address of Domain Name Server 2.
DNS 3	Fill in the IP address of Domain Name Server 3.
Clone MAC Address	Fill in the MAC address that is the MAC address to be cloned. Refer to 4.24 What is Clone MAC Address?
Enable uPNP	Click the checkbox to enable uPNP function. Refer to 4.22 What is Universal Plug and Play (uPNP)?
Enable Web Server Access on WAN	Click the checkbox to enable web configuration from WAN side.
Enable WAN Echo Reply	Click the checkbox to enable WAN ICMP response.
Apply Changes	Click the Apply Changes button to complete the new configuration setting.
Reset	Click the Reset button to abort change and recover the previous configuration setting.

Firewall - Port Filtering

Entries in this table are used to restrict certain types of data packets from your local network to Internet through the Gateway. Use of such filters can be helpful in securing or restricting your local network.

Screen snapshot – Firewall - Port Filtering

Figure 27

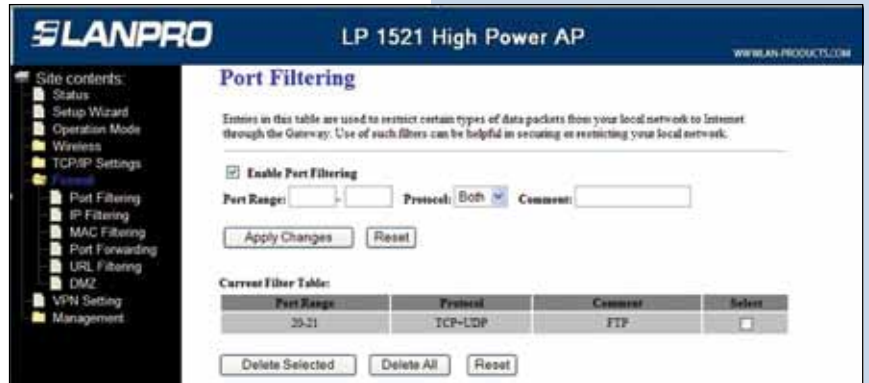

Item	Description
Enable Port Filtering	Click to enable the port filtering security function.
Port Range	To restrict data transmission from the local network on certain ports, fill in the range of start-port and end-port, and the protocol, also put your comments on it. The Protocol can be TCP, UDP or Both. Comments let you know about whys to restrict data from the ports.
Apply Changes	Click the Apply Changes button to register the ports to port filtering list.
Reset	Click the Reset button to abort change and recover the previous configuration setting.
Delete Selected	Click to delete the selected port range that will be removed from the port-filtering list.
Delete All	Click to delete all the registered entries from the port-filtering list.
Reset	Click the Reset button to abort change and recover the previous configuration setting.

Firewall - IP Filtering

Entries in this table are used to restrict certain types of data packets from your local network to Internet through the Gateway. Use of such filters can be helpful in securing or restricting your local network.

Screen snapshot – Firewall - IP Filtering

Figure 28

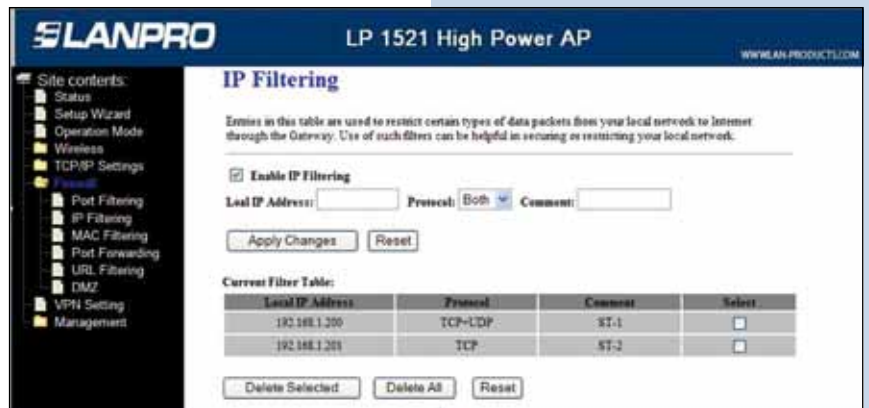

Item	Description
Enable IP Filtering	Click to enable the IP filtering security function.
Local IP Address Protocol Comments	To restrict data transmission from local network on certain IP addresses, fill in the IP address and the protocol , also put your comments on it. The Protocol can be TCP, UDP or Both. Comments let you know about whys to restrict data from the IP address.
Apply Changes	Click the Apply Changes button to register the IP address to IP filtering list.
Reset	Click the Reset button to abort change and recover the previous configuration setting.
Delete Selected	Click to delete the selected IP address that will be removed from the IP-filtering list.
Delete All	Click to delete all the registered entries from the IP-filtering list.
Reset	Click the Reset button to abort change and recover the previous configuration setting.

Firewall - MAC Filtering

Entries in this table are used to restrict certain types of data packets from your local network to Internet through the Gateway. Use of such filters can be helpful in securing or restricting your local network.

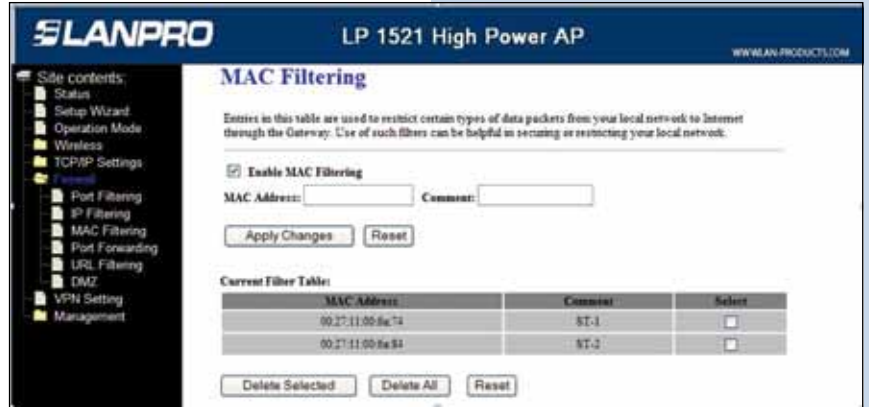

Screen snapshot – Firewall - MAC Filtering
Figure 29

Item	Description
Enable MAC Filtering	Click to enable the MAC filtering security function.
MAC Address Comments	To restrict data transmission from local network on certain MAC addresses, fill in the MAC address and your comments on it.
Apply Changes	Click the Apply Changes button to register the MAC address to MAC filtering list.
Reset	Click the Reset button to abort change and recover the previous configuration setting.
Delete Selected	Click to delete the selected MAC address that will be removed from the MAC-filtering list.
Delete All	Click to delete all the registered entries from the MAC-filtering list.
Reset	Click the Reset button to abort change and recover the previous configuration setting.

Firewall - Port Forwarding

Entries in this table allow you to automatically redirect common network services to a specific machine behind the NAT firewall. These settings are only necessary if you wish to host some sort of server like a web server or mail server on the private local network behind your Gateway's NAT firewall.

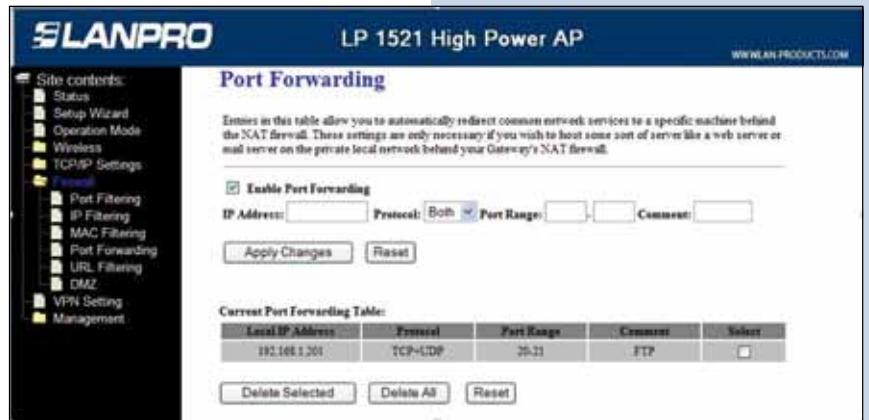

Screen snapshot – Firewall - Port Forwarding
Figure 30

Item	Description
Enable Port Forwarding	Click to enable the Port Forwarding security function.
IP Address Protocol Port Range Comment	To forward data packets coming from WAN to a specific IP address that hosted in local network behind the NAT firewall, fill in the IP address, protocol, port range and your comments. The Protocol can be TCP, UDP or Both. The Port Range for data transmission. Comments let you know about whys to allow data packets forward to the IP address and port number.
Apply Changes	Click the Apply Changes button to register the IP address and port number to Port forwarding list.
Reset	Click the Reset button to abort change and recover the previous configuration setting.
Delete Selected	Click to delete the selected IP address and port number that will be removed from the port-forwarding list.
Delete All	Click to delete all the registered entries from the port-forwarding list.
Reset	Click the Reset button to abort change and recover the previous configuration setting.

Firewall – URL Filtering

URL Filtering is used to restrict users to access specific websites in internet.

Screen snapshot – Firewall – URL Filtering

Figure 31



Item	Description
Enable URL Filtering	Click to enable the URL Filtering function.
URL Address	Add one URL address.
Apply Changes	Click the Apply Changes button to save settings
Reset	Click the Reset button to abort change and recover the previous configuration setting.
Delete Selected	Click to delete the selected URL address that will be removed from the URL Filtering list.
Delete All	Click to delete all the registered entries from the URL Filtering list.
Reset	Click the Reset button to abort change and recover the previous configuration setting.

Firewall - DMZ

A Demilitarized Zone is used to provide Internet services without sacrificing unauthorized access to its local private network. Typically, the DMZ host contains devices accessible to Internet traffic, such as Web (HTTP) servers, FTP servers, SMTP (e-mail) servers and DNS servers.

Screen snapshot – Firewall - DMZ

Figure 32

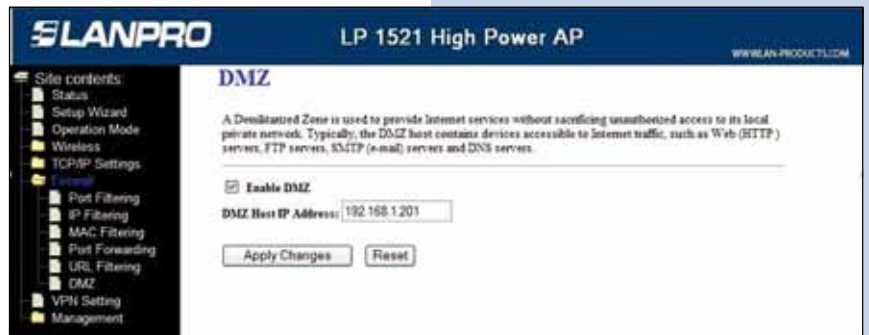

Item	Description
Enable DMZ	Click to enable the DMZ function.
DMZ Host IP Address	To support DMZ in your firewall design, fill in the IP address of DMZ host that can be access from the WAN interface.
Apply Changes	Click the Apply Changes button to register the IP address of DMZ host.
Reset	Click the Reset button to abort change and recover the previous configuration setting.

VPN Setting

This page is used to show VPN connection table, configure IPSEC VPN, NAT Traversal, Generate RSA Key, Show RSA Public Key.

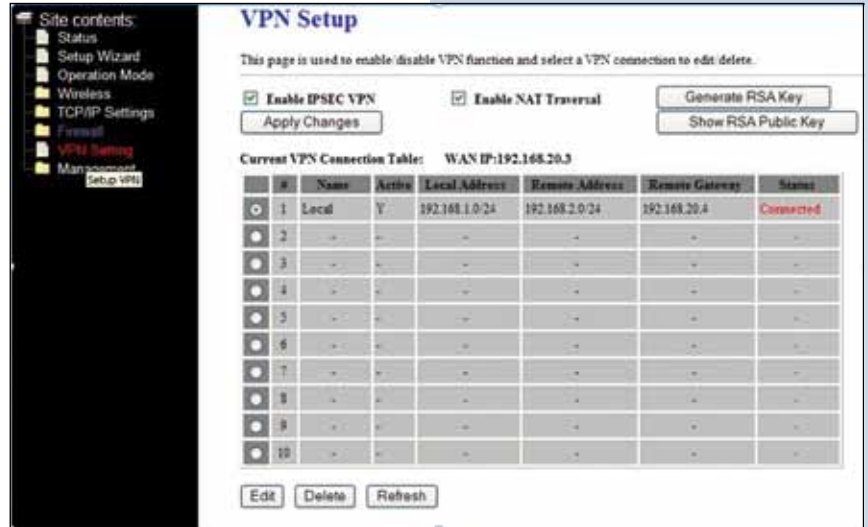

Screen snapshot – VPN Setup

Figure 33

Item	Description
Enable IPSEC VPN	Click to enable IPSEC VPN function. Refer to 4.27 What is VPN? and 4.28 What is IPSEC?
Enable NAT Traversal	Click to enable NAT Traversal function.
Generate RSA Key	Click to generate RSA key.
Show RSA Public Key	Click to show RSA public key that we generate.
Apply Changes	Click the Apply Changes button to enable IPSEC VPN, NAT Traversal settings.
Current VPN Connection Table	It shows current WAN interface information and VPN connection table.
Edit	Click to enter the current VPN tunnel configuration page.
Delete	Click to delete the current VPN tunnel that radio button stay.
Reset	Click to refresh the current VPN connection table.

XIV VPN Setup - Edit Tunnel

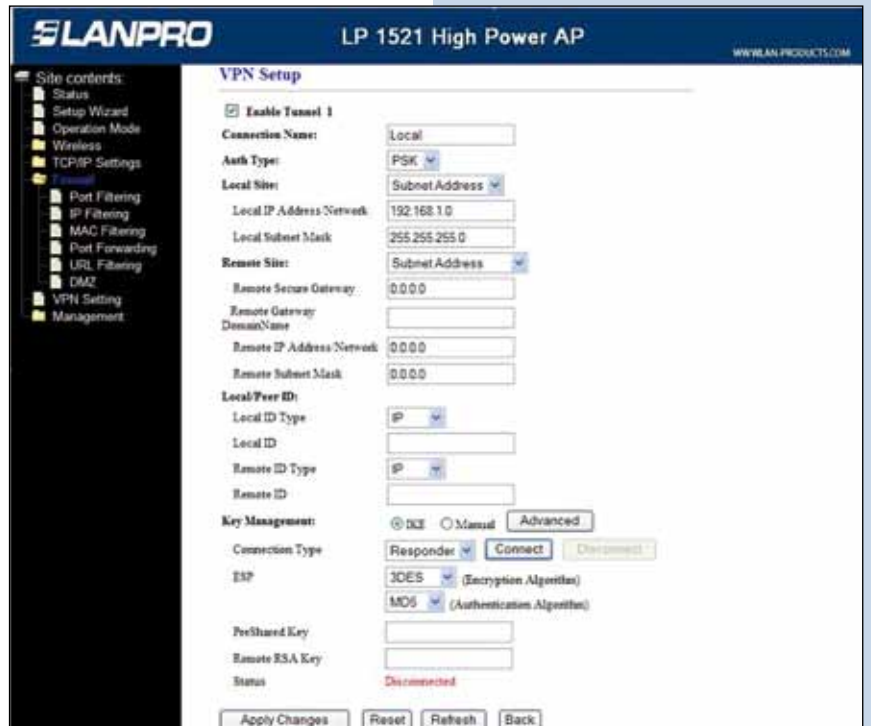

Screen snapshot – VPN Setup-Edit-1

Figure 34

Item	Description
Enable Tunnel #	Click to enable the IPSEC VPN current tunnel.
Connection Name	Assign the connection name tag.
Auth Type	Click to select PSK or RSA .
Local Site Local IP Address/ Network Local Subnet Mask	Click to select Single Address or Subnet Address VPN connection. Fill in IP address or subnet address depends on which Local Site option you choose. Fill in the local subnet mask.
Remote Site Remote Secure Gateway Remote Gateway DomainName Remote IP Address/ Network Remote Subnet Mask	Click to select Single Address, Subnet Address, Any Address or NAT-T Any Address VPN remote connection. Fill in remote gateway IP address Fill in remote gateway Domain Name Fill in IP address or subnet address depends on which Remote Site option you choose. Fill in remote subnet mask
Local/Peer ID Local ID Type Local ID Remote ID Type Remote ID	Define IKE exchange information type Click to select IP, DNS or E-mail as local exchange type Fill in local ID except IP selected Click to select IP, DNS or E-mail as remote exchange type Fill in remote ID except IP selected



Screen snapshot – VPN Setup-Edit-2

Figure 35

Item	Description
Key Management	Click to select IKE or Manual mode.
Advanced	Click Advanced button to configure more IKE settings.
Connection Type	Click to select Initiator or Responder mode.
Connect	Click to connect manually. [Responder mode only]
Disconnect	Click to disconnect manually. [Responder mode only] .
ESP	Click to configure 3DES, AES128 or NULL encryption. Click to configure MD5 or SHA1 authentication.
PreShared Key	Fill in the key value. [IKE mode only]
Remote RSA Key	Fill in the remote gateway RSA key. [IKE mode only]
Status	It shows connection status. [IKE mode only]
SPI	Fill in Security Parameter Index value. [Manual mode only]
Encryption Key	Fill in encryption key. [Manual mode only]
Authentication Key	Fill in authentication key. [Manual mode only]
Apply Change	Click the Apply Changes button to save current tunnel settings.
Reset	Click the Reset button to abort change and recover the previous configuration setting.
Refresh	It shows the current connection status. [Manual mode only]
Back	It returns back to VPN Setup page.

XV Advanced IKE Setup

Advanced VPN Setting for IKE

This This page is used to provide advanced setting for IKE mode

Tunnel 1

Phase 1:

Negotiation Mode Main mode

Encryption Algorithm 3DES ▾

Authenticaiton Algorithm MD5 ▾

Key Group DH2(modp1024) ▾

Key Life Time

Phase 2:

Active Protocol ESP

Encryption Algorithm 3DES ▾

Authenticaiton Algorithm MD5 ▾

Key Life Time

Encapsulation Tunnel mode

Perfect Forward Secrecy (PFS) ON ▾

Screen snapshot – Advanced VPN Settings for IKE

Figure 35

Item	Description
Phase 1	
Negotiation Mode	Main mode.
Encryption Algorithm	Click to select 3DES or AES128 encryption.
Authentication Algorithm	Click to select MD5 or SHA1 authentication.
Key Group	Click to select DH1(modp768) , DH2(modp1024) or DH5(modp1536) key group. Default value is DH2
Key Life Time	Fill in the key life time value by seconds.
Phase 2	
Active Protocol	ESP.
Encryption Algorithm	Click to select 3DES , AES128 or NULL encryption.
Authentication Algorithm	Click to select MD5 or SHA1 authentication.
Key Life Time	Fill in the key life time value by seconds.
Encapsulation	Tunnel mode.
Perfect Forward Secrecy (PFS)	Click to select ON or NONE .
Ok	Click the Ok button to save current tunnel settings.
Cancel	Click the Cancel button to close current window without any changes.

Management - Statistics

This page shows the packet counters for transmission and reception regarding to wireless, Ethernet LAN and Ethernet WAN networks.

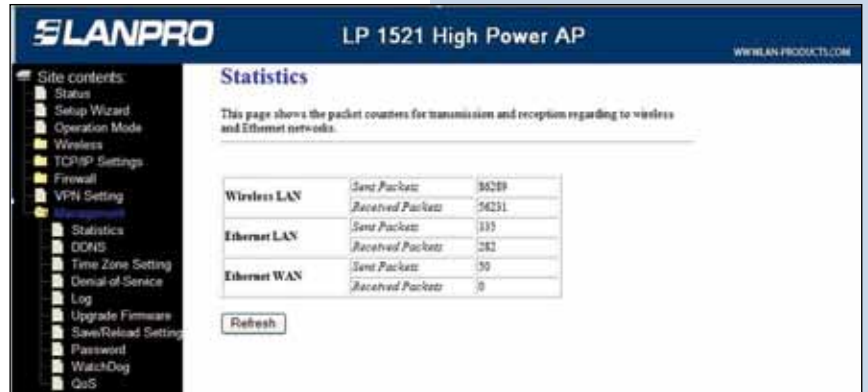

Screen snapshot – Management - Statistics
Figure 36

Item	Description
Wireless LAN Sent Packets	It shows the statistic count of sent packets on the wireless LAN interface.
Wireless LAN Received Packets	It shows the statistic count of received packets on the wireless LAN interface.
Ethernet LAN Sent Packets	It shows the statistic count of sent packets on the Ethernet LAN interface.
Ethernet LAN Received Packets	It shows the statistic count of received packets on the Ethernet LAN interface.
Ethernet WAN Sent Packets	It shows the statistic count of sent packets on the Ethernet WAN interface.
Ethernet WAN Received Packets	It shows the statistic count of received packets on the Ethernet WAN interface.
Refresh	Click the refresh the statistic counters on the screen.

Management - DDNS

This page is used to configure Dynamic DNS service to have DNS with dynamic IP address.



Screen snapshot – Management – DDNS
Figure 37

Item	Description
Enable DDNS	Click the checkbox to enable DDNS service. Refer to 4.25 What is DDNS?
Service Provider	Click the drop down menu to pickup the right provider.
Domain Name	To configure the Domain Name.
User Name/Email	Configure User Name, Email.
Password/Key	Configure Password, Key.
Apply Change	Click the Apply Changes button to save the enable DDNS service.
Reset	Click the Reset button to abort change and recover the previous configuration setting.

Management - Time Zone Setting

This page is used to configure NTP client to get current time.



Figure 38

Screen snapshot – Management – Time Zone Settings

Item	Description
Current Time	It shows the current time.
Time Zone Select	Click the time zone in your country.
Enable NTP client update	Click the checkbox to enable NTP client update. Refer to 4.26 What is NTP Client?
NTP Server	Click select default or input NTP server IP address.
Apply Change	Click the Apply Changes button to save and enable NTP client service.
Reset	Click the Reset button to abort change and recover the previous configuration setting.
Refresh	Click the refresh the current time shown on the screen.

Management – Denial-of-Service

This page is used to enable and setup protection to prevent attack by hacker’s program. It provides more security for users.

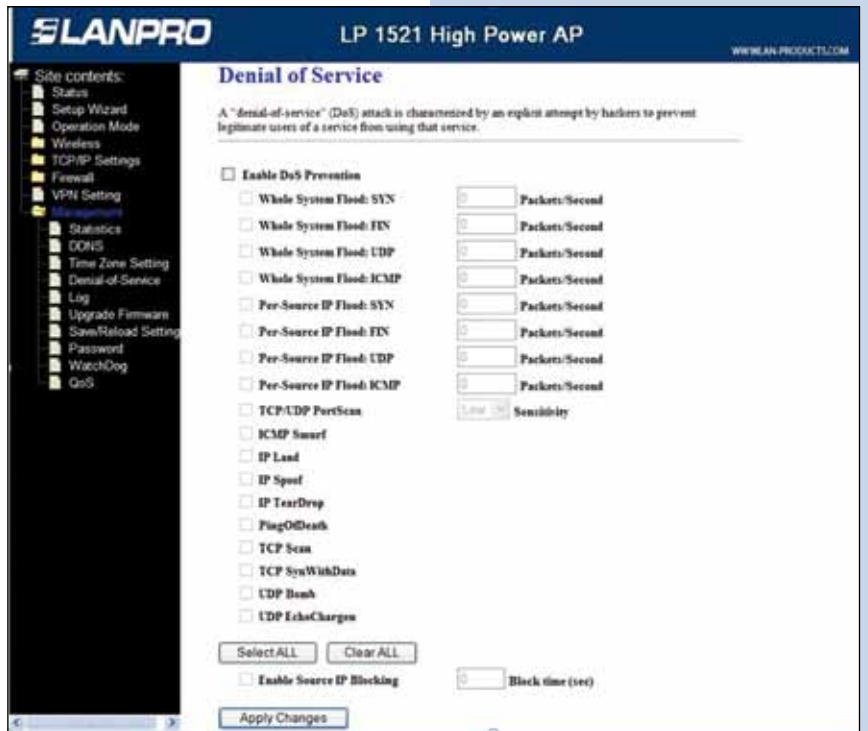

Figure 39

Screen snapshot – Management – Denial-of-Service

Item	Description
Enable DoS Prevention	Click the checkbox to enable DoS prevention.
Whole System Flood / Per-Source IP Flood...	Enable and setup prevention in details.
Select ALL	Click the checkbox to enable all prevention items.
Clear ALL	Click the checkbox to disable all prevention items.
Apply Changes	Click the Apply Changes button to save above settings.

Management - Log

This page is used to configure the remote log server and shown the current log.

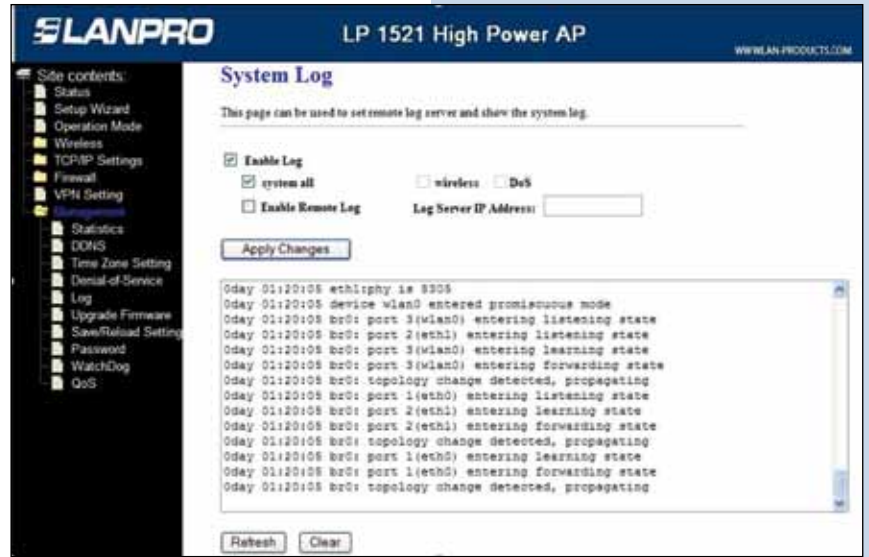

Screen snapshot – Management – Log

Figure 40

Item	Description
Enable Log System all Wirelessy DoS	Click the checkbox to enable log. Show all log of wireless broadband router Only show wireless log Only show Denial-of-Service log
Enable Remote Log Log Server IP Address	Click the checkbox to enable remote log service. Input the remote log IP address
Apply Changes	Click the Apply Changes button to save above settings.
Refresh	Click the refresh the log shown on the screen.
Clear	Clear log display screen

Management - Upgrade Firmware

This page allows you upgrade the Access Point firmware to new version. Please note, do not power off the device during the upload because it may crash the system.



Screen snapshot – Management - Upgrade Firmware

Figure 41

Item	Description
Select File	Click the Browse button to select the new version of web firmware image file.
Upload	Click the Upload button to update the selected web firmware image to the WLAN Broadband Router.
Reset	Click the Reset button to abort change and recover the previous configuration setting.

Management Save/ Reload Settings

This page allows you save current settings to a file or reload the settings from the file that was saved previously. Besides, you could reset the current configuration to factory default.



Screen snapshot – Management - Save/Reload Settings

Figure 42

Item	Description
Save Settings to File	Click the Save button to download the configuration parameters to your personal computer.
Load Settings from File	Click the Browse button to select the configuration files then click the Upload button to update the selected configuration to the WLAN Broadband Router.
Reset Settings to Default	Click the Reset button to reset the configuration parameter to factory defaults.

Management - Password Setup

This page is used to set the account to access the web server of Access Point. Empty user name and password will disable the protection.



Screen snapshot – Management - Password Setup

Figure 43

Item	Description
User Name	Fill in the user name for web management login control.
New Password	Fill in the password for web management login control.
Confirmed Password	Because the password input is invisible, so please fill in the password again for confirmation purpose.
Apply Changes	Clear the User Name and Password fields to empty, means to apply no web management login control. Click the Apply Changes button to complete the new configuration setting.
Reset	Click the Reset button to abort change and recover the previous configuration setting.

Logout

This page is used to logout web management page. This item will be activated next time you login after you define user account and password.

Screen snapshot – Logout

Figure 44



Screen snapshot – Logout - OK

Figure 45



Item	Description
Apply Change	Click the Apply Change button, Then click OK button to logout.

Screen snapshot – Watch Dog settings

Figure 46



Item	Description
Enable Watchdog	Enable Watchdog function.
WatchDog IP Address	Fill in with the IP for Ping
Ping Interval	Fill in with the time in seconds.
Ping Fail to reboot Counter	Fill with the times you will count before reboot.
Apply Changes	Click the Apply Change button to save changes
Reset	Click the Reset button to abort change and recover the previous AP configuration setting.

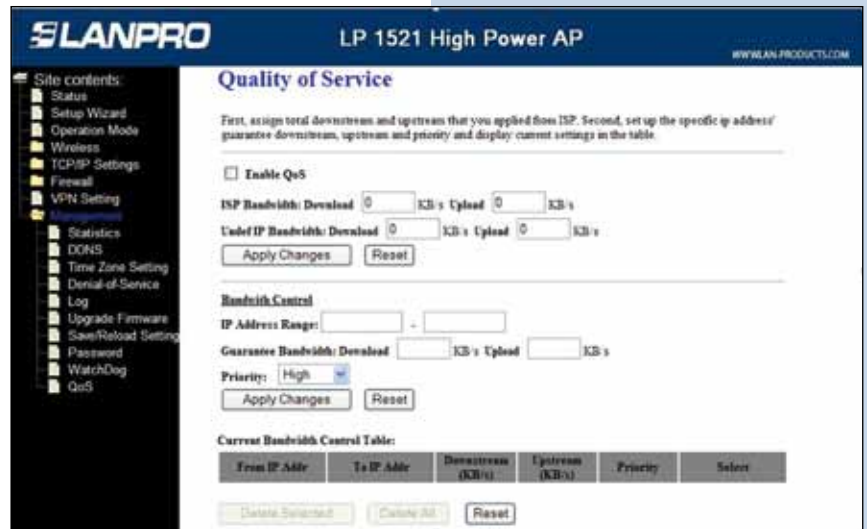

Figure 47

Frequently Asked Questions (FAQ)

What and how to find my PC's IP and MAC address?

IP address is the identifier for a computer or device on a TCP/IP network. Networks using the TCP/IP protocol route messages based on the IP address of the destination. The format of an IP address is a 32-bit numeric address written as four numbers separated by periods. Each number can be zero to 255. For example, 192.168.1.254 could be an IP address.

The MAC (Media Access Control) address is your computer's unique hardware number. (On an Ethernet LAN, it's the same as your Ethernet address.) When you're connected to the Internet from your computer (or host as the Internet protocol thinks of it), a correspondence table relates your IP address to your computer's physical (MAC) address on the LAN.

To find your PC's IP and MAC address:

- Open the Command program in the Microsoft Windows.
- Type in **ipconfig /all** then press the **Enter** button.
- Your PC's IP address is the one entitled IP Address and your PC's MAC address is the one entitled Physical Address.

What is Wireless LAN?

A wireless LAN (WLAN) is a network that allows access to Internet without the need for any wired connections to the user's machine.

What are ISM bands?

ISM stands for Industrial, Scientific and Medical; radio frequency bands that the Federal Communications Commission (FCC) authorized for wireless LANs. The ISM bands are located at 915 +/- 13 MHz, 2450 +/- 50 MHz and 5800 +/- 75 MHz.

How does wireless networking work?

The 802.11 standard define two modes: infrastructure mode and ad hoc mode. In infrastructure mode, the wireless network consists of at least one access point connected to the wired network infrastructure and a set of wireless end stations. This configuration is called a Basic Service Set (BSS). An Extended Service Set (ESS) is a set of two or more BSSs forming a single subnetwork. Since most corporate WLANs require access to the wired LAN for services (file servers, printers, Internet links) they will operate in infrastructure mode.

Ad hoc mode (also called peer-to-peer mode or an Independent Basic Service Set, or IBSS) is simply a set of 802.11 wireless stations that communicate directly with one another without using an access point or any connection to a wired network. This mode is useful for quickly and easily setting up a wireless network anywhere that a wireless infrastructure does not exist or is not required for services, such as a hotel room, convention center, or airport, or where access to the wired network is barred (such as for consultants at a client site).

What is BSSID?

A six-byte address that distinguishes a particular a particular access point from others. Also know as just SSID. Serves as a network ID or name.

What is ESSID?

The Extended Service Set ID (ESSID) is the name of the network you want to access. It is used to identify different wireless networks.

What are potential factors that may causes interference?

Factors of interference:

- Obstacles: walls, ceilings, furniture... etc.
- Building Materials: metal door, aluminum studs.
- Electrical devices: microwaves, monitors and electrical motors.

Solutions to overcome the interferences:

- Minimizing the number of walls and ceilings.
- Position the WLAN antenna for best reception.
- Keep WLAN devices away from other electrical devices, eg: microwaves, monitors, electric motors, ... etc.
- Add additional WLAN Access Points if necessary.

What are the Open System and Shared Key authentications?

IEEE 802.11 supports two subtypes of network authentication services: open system and shared key. Under open system authentication, any wireless station can request authentication. The station that needs to authenticate with another wireless station sends an authentication management frame that contains the identity of the sending station. The receiving station then returns a frame that indicates whether it recognizes the sending station. Under shared key authentication, each wireless station is assumed to have received a secret shared key over a secure channel that is independent from the 802.11 wireless network communications channel.

What is WEP?

An optional IEEE 802.11 function that offers frame transmission privacy similar to a wired network. The Wired Equivalent Privacy generates secret shared encryption keys that both source and destination stations can use to alert frame bits to avoid disclosure to eavesdroppers.

WEP relies on a secret key that is shared between a mobile station (e.g. a laptop with a wireless Ethernet card) and an access point (i.e. a base station). The secret key is used to encrypt packets before they are transmitted, and an integrity check is used to ensure that packets are not modified in transit.

What is Fragment Threshold?

The proposed protocol uses the frame fragmentation mechanism defined in IEEE 802.11 to achieve parallel transmissions. A large data frame is fragmented into several fragments each of size equal to fragment threshold. By tuning the fragment threshold value, we can get varying fragment sizes. The determination of an efficient fragment threshold is an important issue in this scheme. If the fragment threshold is small, the overlap part of the master and parallel transmissions is large. This means the spatial reuse ratio of parallel transmissions is high. In contrast, with a large fragment threshold, the overlap is small and the spatial reuse ratio is low. However high fragment threshold leads to low fragment overhead. Hence there is a trade-off between spatial re-use and fragment overhead.

Fragment threshold is the maximum packet size used for fragmentation. Packets larger than the size programmed in this field will be fragmented.

If you find that your corrupted packets or asymmetric packet reception (all send packets, for example). You may want to try lowering your fragmentation threshold. This will cause packets to be broken into smaller fragments. These small fragments, if corrupted, can be resent faster than a larger fragment. Fragmentation increases overhead, so you'll want to keep this value as close to the maximum value as possible.

What is RTS (Request To Send) Threshold?

The RTS threshold is the packet size at which packet transmission is governed by the RTS/CTS transaction. The IEEE 802.11-1997 standard allows for short packets to be transmitted without RTS/CTS transactions. Each station can have a different RTS threshold. RTS/CTS is used when the data packet size exceeds the defined RTS threshold. With the CSMA/CA transmission mechanism, the transmitting station sends out an RTS packet to the receiving station, and waits for the receiving station to send back a CTS (Clear to Send) packet before sending the actual packet data.

This setting is useful for networks with many clients. With many clients, and a high network load, there will be many more collisions. By lowering the RTS threshold, there may be fewer collisions, and performance should improve. Basically, with a faster RTS threshold, the system can recover from problems faster. RTS packets consume valuable bandwidth, however, so setting this value too low will limit performance.

What is Beacon Interval?

In addition to data frames that carry information from higher layers, 802.11 includes management and control frames that support data transfer. The beacon frame, which is a type of management frame, provides the "heartbeat" of a wireless LAN, enabling stations to establish and maintain communications in an orderly fashion.

Beacon Interval represents the amount of time between beacon transmissions. Before a station enters power save mode, the station needs the beacon interval to know when to wake up to receive the beacon (and learn whether there are buffered frames at the access point).

What is Preamble Type?

There are two preamble types defined in IEEE 802.11 specification. A long preamble basically gives the decoder more time to process the preamble. All 802.11 devices support a long preamble. The short preamble is designed to improve efficiency (for example, for VoIP systems). The difference between the two is in the Synchronization field. The long preamble is 128 bits, and the short is 56 bits.

What is SSID Broadcast?

Broadcast of SSID is done in access points by the beacon. This announces your access point (including various bits of information about it) to the wireless world around it. By disabling that feature, the SSID configured in the client must match the SSID of the access point.

Some wireless devices don't work properly if SSID isn't broadcast (for example the D-link DWL-120 USB 802.11b adapter). Generally if your client hardware supports operation with SSID disabled, it's not a bad idea to run that way to enhance network security. However it's no replacement for WEP, MAC filtering or other protections.

What is Wi-Fi Protected Access (WPA)?

Wi-Fi's original security mechanism, Wired Equivalent Privacy (WEP), has been viewed as insufficient for securing confidential business communications. A longer-term solution, the IEEE 802.11i standard, is under development. However, since the IEEE 802.11i standard is not expected to be published until the end of 2003, several members of the Wi-Fi Alliance teamed up with members of the IEEE 802.11i task group to develop a significant near-term enhancement to Wi-Fi security. Together, this team developed Wi-Fi Protected Access.

To upgrade a WLAN network to support WPA, Access Points will require a WPA software upgrade. Clients will require a software upgrade for the network interface card, and possibly a software update for the operating system. For enterprise networks, an authentication server, typically one that supports RADIUS and the selected EAP authentication protocol, will be added to the network.

What is WPA2?

It is the second generation of WPA. WPA2 is based on the final IEEE 802.11i amendment to the 802.11 standard.

What is 802.1x Authentication?

802.1x is a framework for authenticated MAC-level access control, defines Extensible Authentication Protocol (EAP) over LANs (WAPOL). The standard encapsulates and leverages much of EAP, which was defined for dial-up authentication with Point-to-Point Protocol in RFC 2284.

Beyond encapsulating EAP packets, the 802.1x standard also defines EAPOL messages that convey the shared key information critical for wireless security.

What is Temporal Key Integrity Protocol (TKIP)?

The Temporal Key Integrity Protocol, pronounced tee-kip, is part of the IEEE 802.11i encryption standard for wireless LANs. TKIP is the next generation of WEP, the Wired Equivalency Protocol, which is used to secure 802.11 wireless LANs. TKIP provides per-packet key mixing, a message integrity check and a re-keying mechanism, thus fixing the flaws of WEP.

What is Advanced Encryption Standard (AES)?

Security issues are a major concern for wireless LANs, AES is the U.S. government's next-generation cryptography algorithm, which will replace DES and 3DES.

What is Inter-Access Point Protocol (IAPP)?

The IEEE 802.11f Inter-Access Point Protocol (IAPP) supports Access Point Vendor interoperability, enabling roaming of 802.11 Stations within IP subnet.

IAPP defines messages and data to be exchanged between Access Points and between the IAPP and high layer management entities to support roaming. The IAPP protocol uses TCP for inter-Access Point communication and UDP for RADIUS request/response exchanges. It also uses Layer 2 frames to update the forwarding tables of Layer 2 devices.

What is Wireless Distribution System (WDS)?

The Wireless Distribution System feature allows WLAN AP to talk directly to other APs via wireless channel, like the wireless bridge or repeater service.

What is Universal Plug and Play (uPNP)?

UPnP is an open networking architecture that consists of services, devices, and control points. The ultimate goal is to allow data communication among all UPnP devices regardless of media, operating system, programming language, and wired/wireless connection.

What is Maximum Transmission Unit (MTU) Size?

Maximum Transmission Unit (MTU) indicates the network stack of any packet is larger than this value will be fragmented before the transmission. During the PPP negotiation, the peer of the PPP connection will indicate its MRU and will be accepted. The actual MTU of the PPP connection will be set to the smaller one of MTU and the peer's MRU. The default is value 1400.

What is Clone MAC Address?

Clone MAC address is designed for your special application that request the clients to register to a server machine with one identified MAC address.

Since that all the clients will communicate outside world through the WLAN Broadband Router, so have the cloned MAC address set on the WLAN Broadband Router will solve the issue.

What is DDNS?

DDNS is the abbreviation of Dynamic Domain Name Server. It is designed for user own the DNS server with dynamic WAN IP address.

What is NTP Client?

NTP client is designed for fetching the current timestamp from internet via Network Time protocol. User can specify time zone, NTP server IP address.

What is VPN?

VPN is the abbreviation of Virtual Private Network. It is designed for creating point-to point private link via shared or public network.

What is IPSEC?

IPSEC is the abbreviation of IP Security. It is used to transferring data securely under VPN.

TECHNICAL SUPPORT

support@lanpro.com