

SCALE 2/1

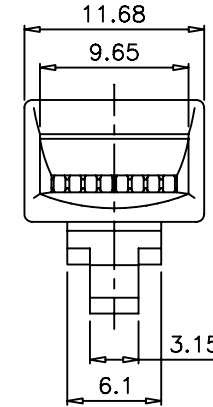
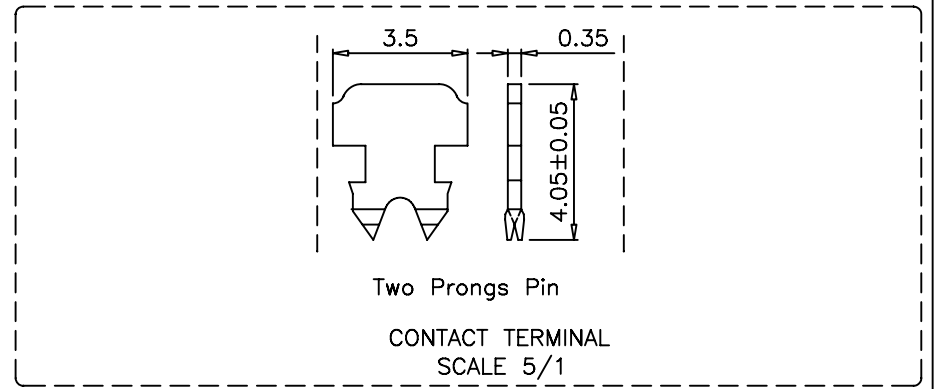
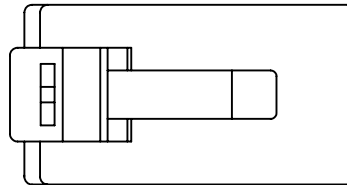
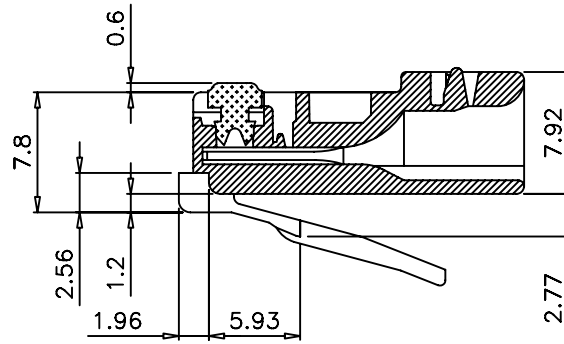
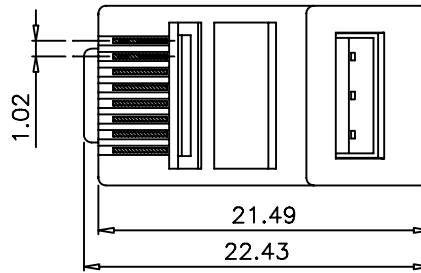
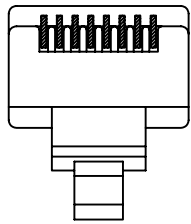

GENERAL TOLERANCE OF DIMENSIONS ±0.1

DRAWING	22.JUN.2005	YL
CHECK	22.JUN.2005	KC
APPROVAL	22.JUN.2005	GR

**LANPRO**  
How Information Moves...

	DATE	NAME	ITEM NO.: LP-RJ458P8CCEUS11
SCALE	2/1 (A4)	UNIT	mm
DES.: Plug CAT 5e 8P8C 1 parte sin blindar de dos puntas			

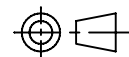

DRAWING NO.	LPRJ458P8CCEUS11_DD_SPB01W
DRAWING CLASSIFICATION	S SHEET 1 OF 1

