

1 2 3 4 5 6

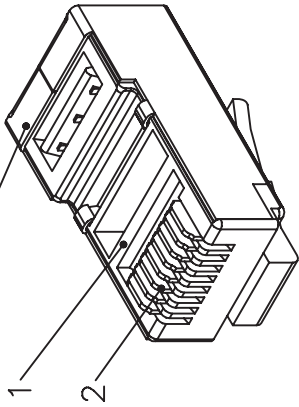

SCALE 2/1

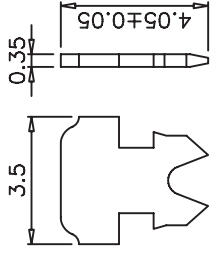
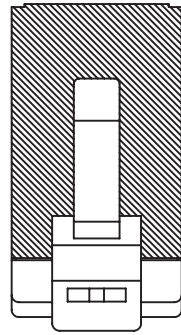
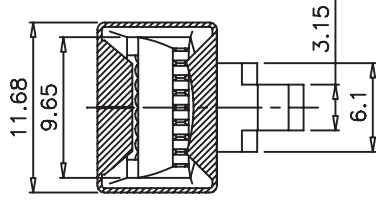
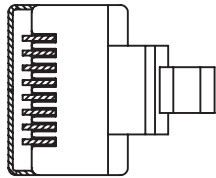
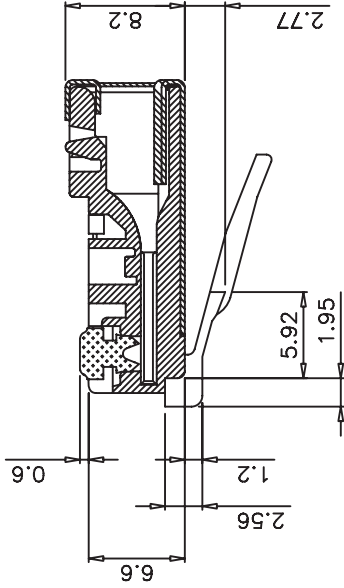
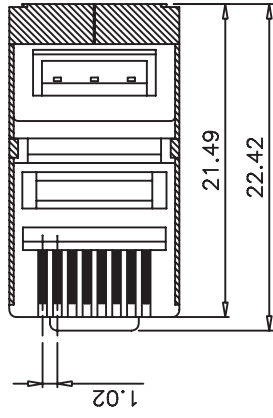

Straight Pin
CONTACT TERMINAL
SCALE 5/1
TOL: ±0.05

A

B

C

D

GENERAL TOLERANCE OF DIMENSIONS ±0.1

DRAWING	23.JUN.2005	BF
CHECK	23.JUN.2005	GR
APPROVAL	23.JUN.2005	EF
SCALE	2/1 (A4)	UNIT
	DATE	NAME
		m m

	DRAWING NO.	LPRJ458P8CCEFS_DD_SPB01W.pdf
	DRAWING CLASSIFICATION	S SHEET 1 OF 1

ITEM NO.:	LP-RJ458P8CCEFS
DES.:	Plug RJ458P8CCEFS blindado, 1 parte, 2 puntas centradas para conductores

1 2 3 4 5 6 10cm