

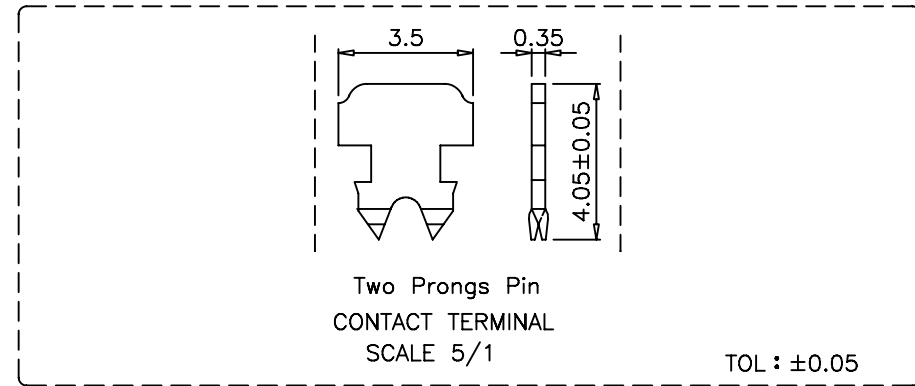

SCALE 2/1

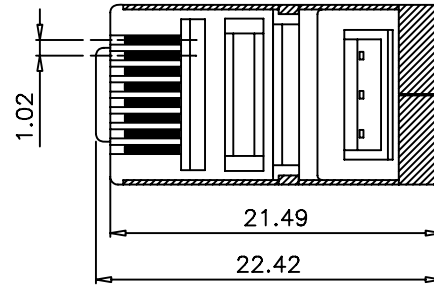
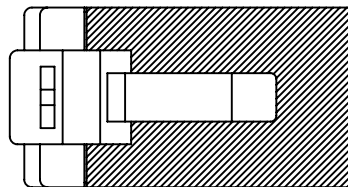
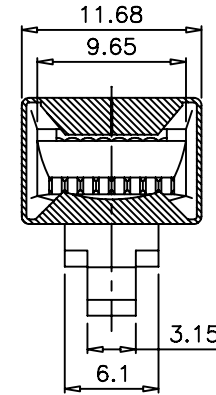
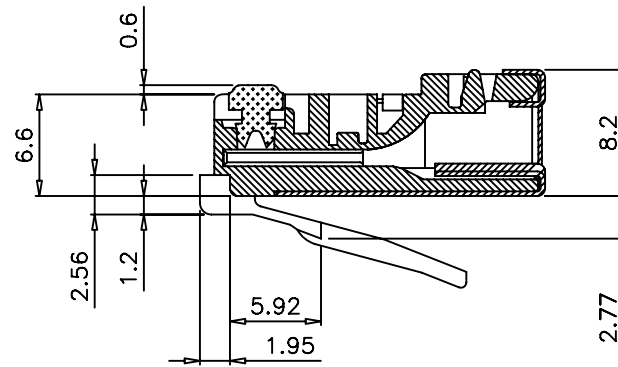
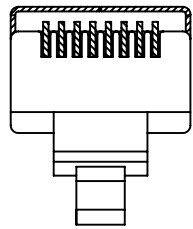

Two Prongs Pin  
CONTACT TERMINAL  
SCALE 5/1

TOL : ±0.05



GENERAL TOLERANCE OF DIMENSIONS ±0.1	DRAWING	23.JUN.2005	YL	
	CHECK	23.JUN.2005	KC	
	APPROVAL	23.JUN.2005	GR	
		DATE	NAME	ITEM NO.: LP-RJ458P8CCEFS11
	SCALE	2/1 (A4)	UNIT	mm
	DRAWING NO. LPRJ458P8CCEFS11_DD_SPB01W			
	DRAWING CLASSIFICATION		S	SHEET 1 OF 1

