

1 2 3 4 5 6

A

B

C

D

A

B

C

D

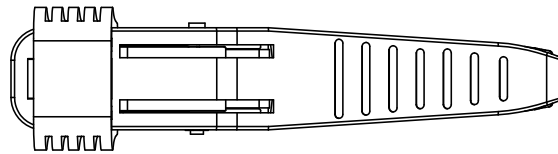
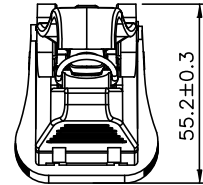
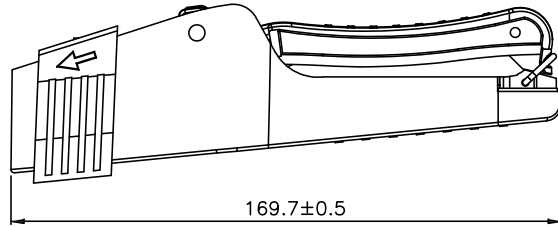
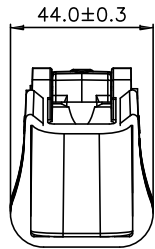
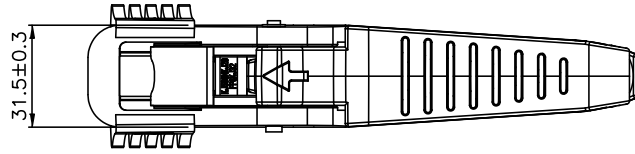
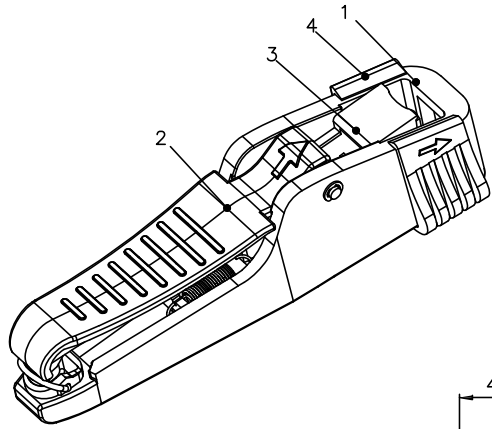

GENERAL TOLERANCE OF DIMENSIONS X.XXX ±0.005 X.XX ±0.05 X.X ±0.1	DRAWING	17.SEP.2015	YL	 <b>LANPRO</b> Connect-and-Forget	
	CHECK	17.SEP.2015	YL		
	APPROVAL	17.SEP.2015	KM		
		DATE	NAME	ITEM NO.: LPT-AR02	
	SCALE	1/4 (A4)	UNIT	mm	DES.: Herramienta de compresión para plugs LP-TCRJ458P8CCAFS
					DRAWING NO. LPTAR02_DD_SPB01W
					DRAWING CLASSIFICATION
					S SHEET 1 OF 1
					A1

1 2 3 4 5 6

10cm