

1 2 3 4 5 6

A

A

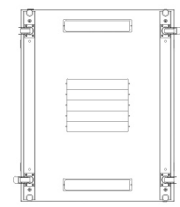
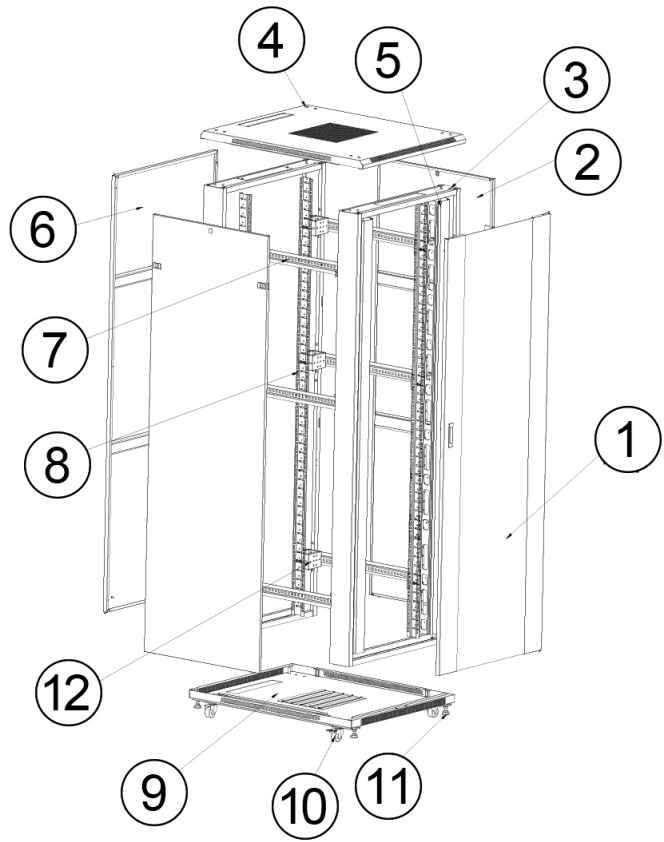

Vista inferior

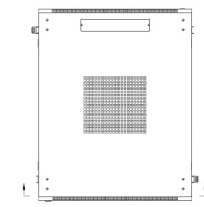

Vista superior

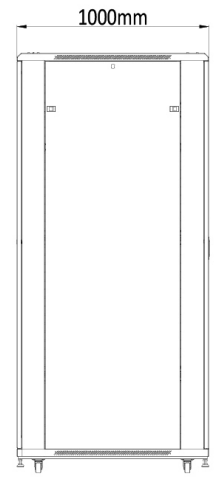

Vista lateral

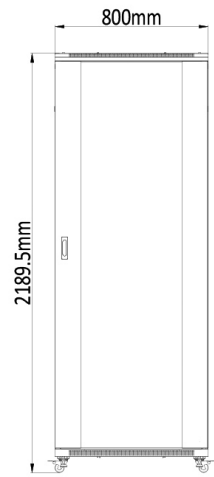

Vista frontal

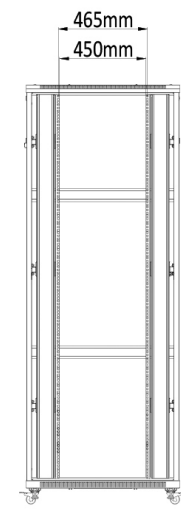

Vista seccional

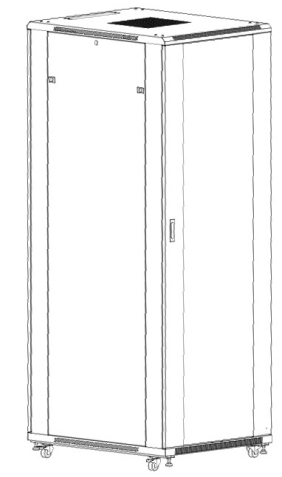



B

B

C

C

S/N	Descripción	Cant
12	Caja de conexión	12
11	Patas niveladoras	4
10	Ruedas (2 con freno)	4
9	Placa inferior	1
8	Riel Vertical	4
7	Barra horizontal	6
6	Puerta trasera	1
5	Riel para gestión de cables	2
4	Cubierta superior	1
3	Marco de la puerta	2
2	Panel lateral	2
1	Puerta frontal	1

GENERAL TOLERANCE OF DIMENSIONS X.XXX ±0.005 X.XX ±0.05 X.X ±0.1	DATE	NAME	 Connect-and-Forget	
	DRAWING	NOV 2017		YL
	CHECK	NOV 2017		YL
	APPROVAL	NOV 2017	KM	ITEM NO.: LP-R70610845
	SCALE	1/5 (A4)	UNIT	mm
DRAWING NO.		LPR70610845_DD_SPB01W		
DRAWING CLASSIFICATION		S	SHEET 1 OF 1	

D

D

1 2 3 4 5 6 10cm