

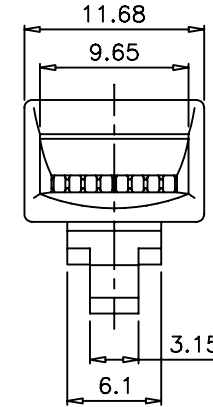

SCALE 2/1

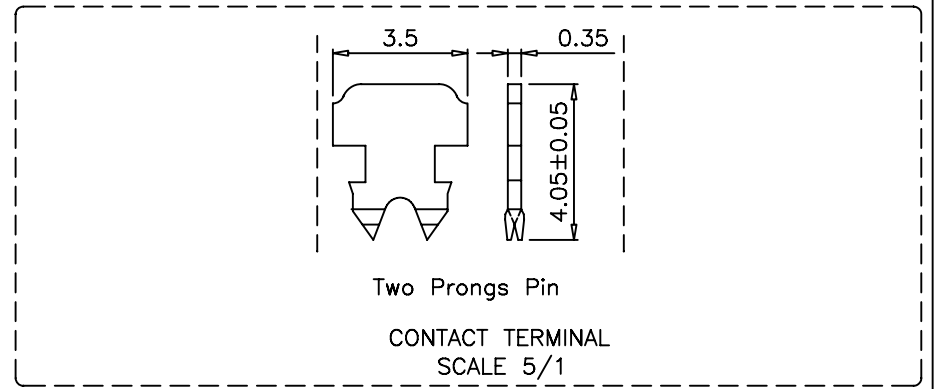
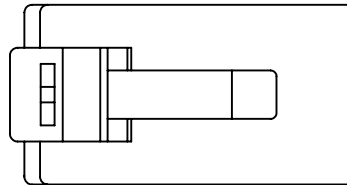
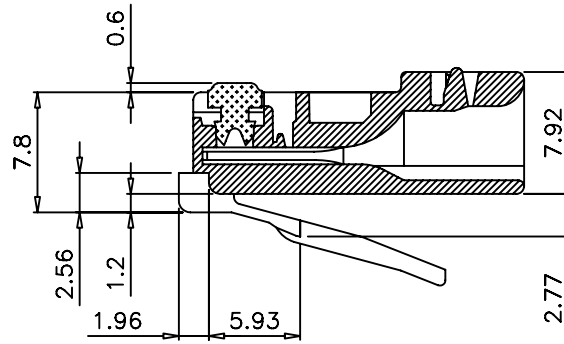
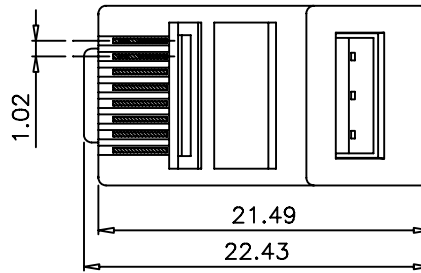
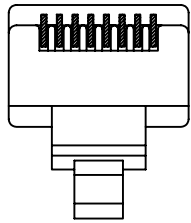

GENERAL TOLERANCE OF DIMENSIONS ±0.1

|  |             |         |   |
|--|-------------|---------|---|
| DRAWING                                | 22.JUN.2005 | YL      |  |
| CHECK                                  | 22.JUN.2005 | KC      |   |
| APPROVAL                               | 22.JUN.2005 | GR      |   |
| DATE                                   |             | NAME    | ITEM NO.: LP-RJ458P8CCEUS11   |
| SCALE                                  | 2/1 (A4)    | UNIT    | mm  |
| DRAWING NO. LPRJ458P8CCEUS11_DD_ENB01W |             |         |  |
| DRAWING CLASSIFICATION                 |             | S SHEET |   |