

SCALE 2/1

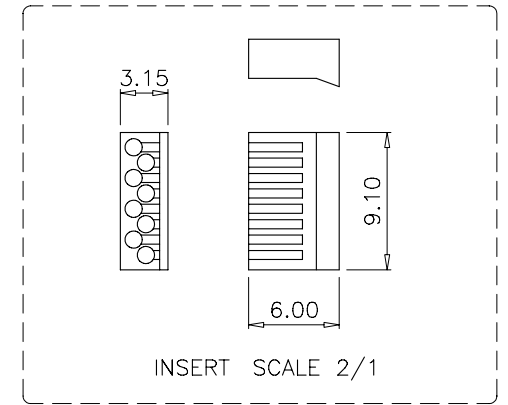

GENERAL TOLERANCE OF DIMENSIONS ±0.1	DRAWING	1.NOV.2011	YL	<p>LANPRO How Information Moves...</p>	
	CHECK	1.NOV.2011	KC		
	APPROVAL	1.NOV.2011	GR		
		DATE	NAME	ITEM NO.: LP-RJ458P8CC6FS21	
	SCALE	2/1 (A4)	UNIT	mm	DES.: 8P8C CAT6 2 PART PLUG SHIELDED 2 PRONG SLANTED
	DRAWING NO. LPRJ458P8CC6FS21_DD_ENB01W				
	DRAWING CLASSIFICATION		S	SHEET	1 OF 1

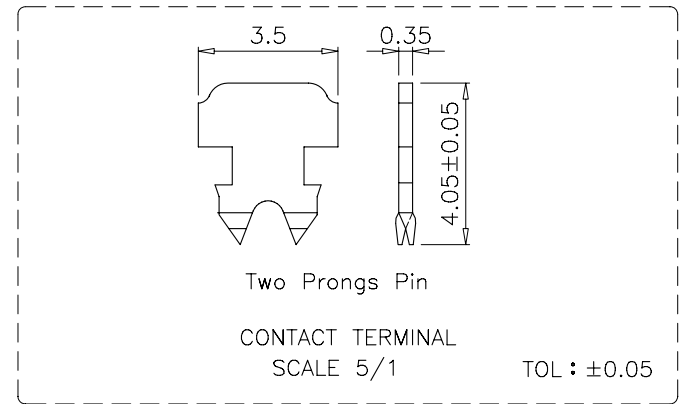
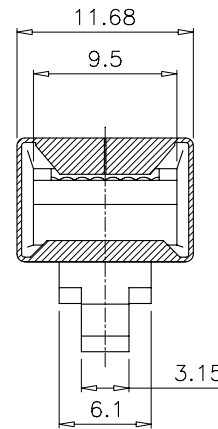
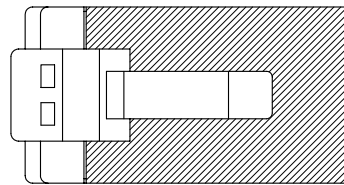
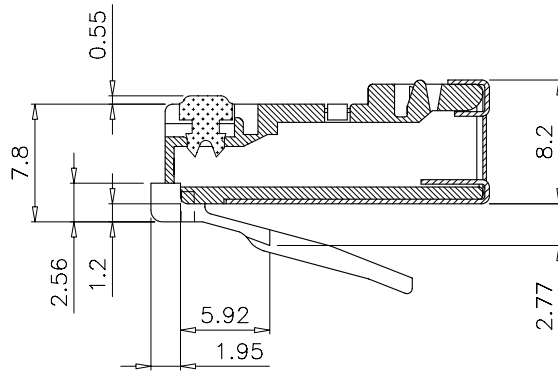
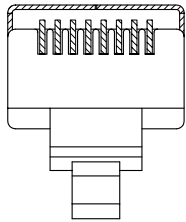
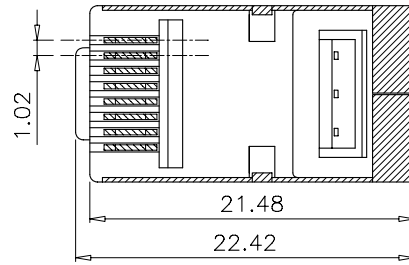