

1 2 3 4 5 6



A

B

C

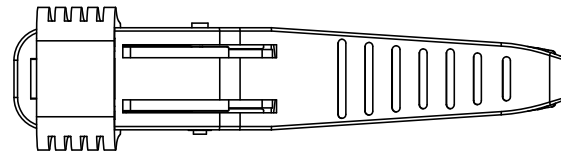
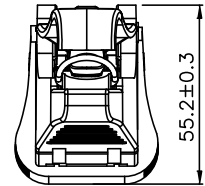
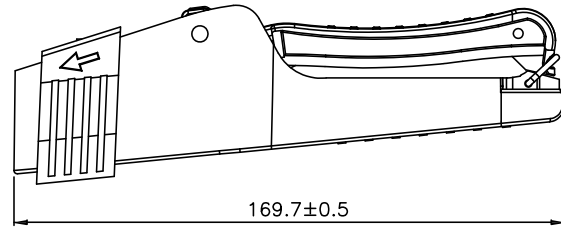
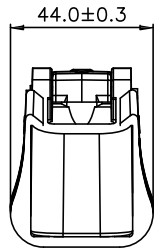
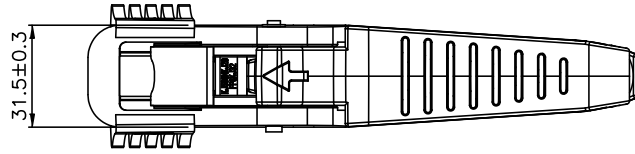
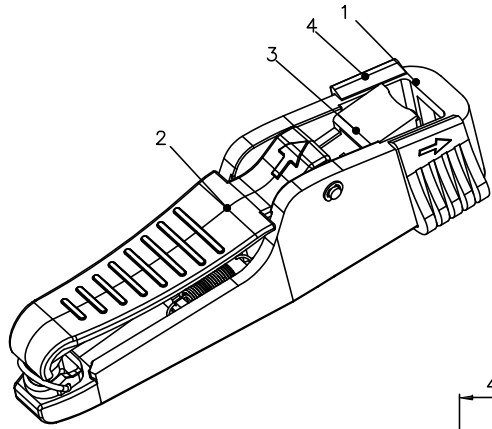
D

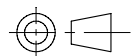

GENERAL TOLERANCE OF DIMENSIONS X.XXX ±0.005 X.XX ±0.05 X.X ±0.1	DRAWING	17.SEP.2015	YL	 LANPRO Connect-and-Forget	
	CHECK	17.SEP.2015	YL		
	APPROVAL	17.SEP.2015	KM		
	DATE		NAME		ITEM NO.: LPT-AR02
SCALE		1/4 (A4)	UNIT	mm	DES.: Crimping tool for LP-TCRJ458P8CC6 RJ45 8P8C CAT 6
		DRAWING NO.		LPTAR02_DD_ENB01W	
		DRAWING CLASSIFICATION		S SHEET	

1 2 3 4 5 6

10cm